



TABELA DE PREÇOS

2025

Validade 28.02.2026



# CHAVES MACHO SEXTAVADAS

As chaves macho sextavadas da Beta são concebidas para trabalhos longos e precisos.

A ampla gama cobre todos os requisitos de utilização: extracurtas, curtas, longas, extralongas, com ponta de bola, em T, ou com punho de aperto elevado, estas chaves incluem-se nos produtos que mais se destacam na gama Beta, sem rival à altura no mercado.

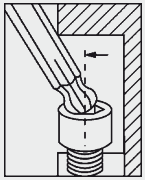

As chaves ponta de bola permitem trabalhar a um ângulo até 30° do eixo do parafuso.

As chaves são fornecidas numa bolsa para rápida identificação do tamanho desejado. Quando fechada, garante que as chaves estão protegidas e não se perdem, mesmo as de menor dimensão. A versão colorida combina as características excecionais das chaves standard com a identificação imediata do tamanho desejado, para facilitar o trabalho diário.

## 96

chaves macho hexagonal cromadas



ISO 2936

mm	L	L1	€	🔧	📦
0,9	35	8	1,11	20	000960013
1,3	39	10	1,11	20	000960014
1,5	45	15	1,11	20	000960015
2	50	17	1,18	20	000960020
2,5	57	20	1,18	20	000960025
3	64	22	1,38	20	000960030
3,5	68	25	1,65	20	000960035
4	72	28	1,72	20	000960040
4,5	78	30	1,78	20	000960045
5	83	32	1,84	20	000960050
5,5	88	35	2,32	20	000960055
6	94	37	2,32	20	000960060
7	99	40	2,88	10	000960070
8	105	43	3,40	10	000960080
9	111	46	4,00	10	000960090
10	119	49	4,75	10	000960100
11	126	52	6,00	10	000960110
12	134	56	7,20	10	000960120
13	142	62	9,20	10	000960130
14	151	69	10,70	10	000960140
16	165	75	15,70	5	000960160
17	174	79	16,50	5	000960170
19	196	88	23,00	5	000960190
22	216	100	36,00	3	000960220
24	242	112	47,50	1	000960240
27	271	125	63,00	1	000960270
30	309	140	84,50	1	000960300
32	341	155	112,00	1	000960312
36	385	174	161,00	1	000960316



96/ST6  
2,5-3-4-5-6-8 mm € 16,10 3 000960370



96/BGS7  
1,5-2-2,5-3-4-5-6 mm € 35,50 1 000960367



96/BG7  
2,5-3-4-5-6-8-10 mm € 37,50 1 000960368



96/B8  
2-2,5-3-4-5-6-8-10 mm € 20,00 5 000960386

96/B10  
1,5-2-2,5-3-4-5-6-8-10-12 mm € 28,50 5 000960380

96N/BV € 2,17 1 000960651



96/SC9  
1,5-2-2,5-3-4-5-6-8-10 mm € 23,80 1 000960374

96/SCV € 4,85 1 000960985



96/SC12  
2-2,5-3-3,5-4-4,5-5-6-7-8-9-10 mm € 34,00 1 000960395

96/SCV12 € 5,80 1 000960975

## 96N

chaves macho hexagonal, brunidas



ISO 2936

mm	L mm	L1 mm	€	🔧	📦
0,9	32	10	0,56	20	000960409
1,3	44	12	0,56	20	000960413
1,5	46	15	0,59	20	000960415
2	51	17	0,62	20	000960420
2,5	57	20	0,64	20	000960425
3	64	22	0,72	20	000960430
3,5	68	25	0,86	20	000960435
4	72	28	0,98	20	000960440
4,5	78	30	1,07	20	000960445
5	83	32	1,12	20	000960450
6	94	37	1,41	20	000960460
7	99	40	1,87	10	000960470
8	105	43	2,22	10	000960480
9	111	46	2,90	10	000960490
10	119	49	3,45	10	000960500
11	126	52	4,25	10	000960510
12	134	56	5,20	10	000960520
13	142	62	7,00	10	000960530
14	151	69	7,80	10	000960540
16	165	72	11,80	5	000960560
17	174	79	12,70	5	000960570
19	194	88	17,20	5	000960590
22	216	99	31,50	1	000960592
24	242	111	41,50	1	000960594



**96N/ST6** € 11,30 3 000960640  
2,5-3-4-5-6-8 mm



**96N/G7** € 29,50 3 000960645  
2,5-3-4-5-6-8-10 mm  
**96N/G7A** € 20,70 3 000960643  
1,5-2-2,5-3-4-5-6 mm



**96N/B10** € 19,10 5 000960650  
1,5-2-2,5-3-4-5-6  
8-10-12 mm  
**96N/BV** € 2,17 1 000960651



**96N/SC9** € 16,60 1 000960644  
1,5-2-2,5-3-4-5-6-8-10 mm  
**96N/SCV** € 4,85 1 000960986



**96N/SC12** € 23,70 1 000960661  
2-2,5-3-3,5-4-4,5-5  
6-7-8-9-10 mm  
**96N/SCV12** € 5,80 1 000960976



**96C-AS/SC9** € 40,50 1 000961753  
1/16-3/32-1/8-5/32-3/16-  
7/32-1/4-5/16-3/8

### 96AS

chaves macho hexagonal, brunidas



"	L mm	L1 mm	€		
1/30 (0,035")	44	14	0,99	20	000960698
1/20 (0,050")	44	15	0,99	20	000960701
1/16	46	16	1,07	20	000960702
5/64	50	18	1,32	20	000960704
3/32	53	19	1,52	20	000960706
7/64	57	21	1,56	20	000960708
1/8	60	22	1,58	20	000960710
9/64	64	24	1,89	20	000960712
5/32	68	25	1,95	20	000960714
3/16	75	29	2,17	20	000960716
7/32	82	32	2,43	20	000960718
1/4	89	35	2,84	20	000960720
5/16	103	40	3,55	10	000960724
3/8	117	44	4,30	10	000960728
7/16	132	49	6,30	10	000960730
1/2	149	54	8,00	10	000960732
9/16	151	69	13,00	2	000960734



**96AS/SC9** € 26,50 1 000960743  
1/16-3/32-1/8-5/32-3/16  
7/32-1/4-5/16-3/8  
**96AS/SCV** € 4,85 1 000960744



**96AS/T7** € 21,30 3 000960740  
3/32-1/8-5/32  
3/16-7/32-1/4-5/16



**96AS/BG7** € 37,50 1 000960747  
3/32-1/8-5/32-3/16  
1/4-5/16-3/8



**96AS/B11** € 26,00 1 000960749  
1/20-1/16-5/64-3/32  
1/8-5/32-3/16-7/32  
1/4-5/16-3/8  
**96N/BV** € 2,17 1 000960651

### 96LC

chaves macho hexagonal  
série longa, cromadas



ISO 2936

mm	L mm	L1 mm	€		
2	101	17	2,11	20	000960320
2,5	113	20	2,26	20	000960321
3	127	22	2,46	20	000960322
3,5	138	25	2,52	20	000960323
4	142	28	2,74	20	000960324
4,5	154	28	3,20	20	000960325
5	163	32	3,50	20	000960326
6	184	37	3,75	20	000960327
7	194	40	4,30	10	000960328
8	205	43	5,30	10	000960329
9	216	46	5,90	10	000960330
10	231	49	7,60	10	000960331
12	259	56	9,40	10	000960332



**96LC/SC8** € 34,50 1 000960334  
2-2,5-3-4-5-6-8-10 mm  
**96LC/SCV** € 4,85 1 000960983



**96LC/SC12** € 51,50 1 000960337  
2-2,5-3-3,5-4-4,5-5  
6-7-8-9-10 mm  
**96LC/SCV12** € 5,80 1 000960977



## 96L

chaves macho hexagonal  
série longa, brunidas



ISO 2936

mm	L mm	L1 mm	€	🔧	📦
2	99	15	1,49	20	000960820
2,5	110	17	1,55	20	000960825
3	124	19	1,75	20	000960830
3,5	135	21	1,89	20	000960835
4	138	24	2,09	20	000960840
4,5	150	25	2,43	20	000960845
5	158	27	2,56	20	000960850
6	178	31	2,90	20	000960860
7	187	33	3,70	10	000960870
8	197	35	4,70	10	000960880
9	207	37	5,30	10	000960890
10	221	39	7,00	10	000960900
12	247	44	9,00	10	000960920



96L/SC8	€ 29,00	🔧 1	📦 000960924
2-2,5-3-4-5-6-8-10 mm			
96L/SCV	€ 4,85	🔧 1	📦 000960987



96L/SC12	€ 43,00	🔧 1	📦 000960929
2-2,5-3-3,5-4-4,5-5-6-7-8-9-10 mm			
96L/SCV12	€ 5,80	🔧 1	📦 000960978

## 96BP-CL

chaves de caixa sextavadas, macho, com  
ponta esférica, cromadas, coloridas



mm	L mm	L1 mm	€	🔧	📦
1,5	91	16	3,30	5	000961600
2	102	17	3,70	5	000961601
2,5	113	21	4,10	5	000961602
3	128	23	4,60	5	000961603
4	143	28	5,10	5	000961604
5	163	33	5,60	5	000961605
6	185	37	7,10	5	000961606
8	206	43	9,60	2	000961608
10	231	50	12,70	2	000961610



96BP-CL/SC9	€ 60,50	🔧 1	📦 000961619
1,5-2-2,5-3-4-5-6-8-10 mm			
96BP-CL/SCV	€ 4,85	🔧 1	📦 000961629

## 96BPC

chaves macho hexagonal  
com uma extremidade esférica  
cromadas

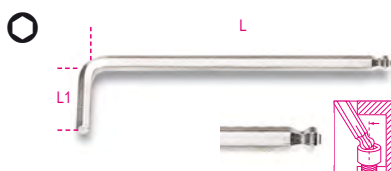

mm	L mm	L1 mm	€	🔧	📦
1,5	79	13	2,50	10	000960340
2	84	15	2,63	10	000960341
2,5	89	17	2,76	10	000960342
3	99	19	2,95	10	000960343
4	108	24	3,40	10	000960344
5	126	27	4,10	10	000960345
6	148	31	5,90	10	000960346
7	157	33	7,70	5	000960353
8	168	35	7,80	5	000960347
10	187	39	12,70	5	000960348
12	220	55	16,30	5	000960352



96BPC/SC9	€ 49,50	🔧 1	📦 000960354
1,5-2-2,5-3-4-5-6-8-10 mm			
96BPC/SCV	€ 4,85	🔧 1	📦 000960984

## 96BP

chaves macho hexagonal com uma  
extremidade esférica, brunidas

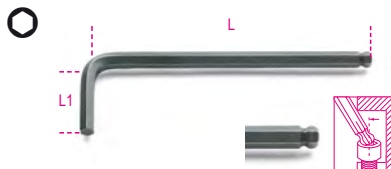

mm	L mm	L1 mm	€	🔧	📦
1,5	79	13	1,89	10	000960960
2	84	15	2,02	10	000960961
2,5	89	17	2,09	10	000960962
3	99	19	2,17	10	000960963
4	108	24	2,50	10	000960965
5	126	27	3,30	10	000960967
6	148	31	4,75	10	000960968
8	168	35	6,90	5	000960970
10	187	39	11,60	5	000960972
12	220	55	17,30	5	000960973



96BP/SC9	€ 42,00	🔧 1	📦 000960974
1,5-2-2,5-3-4-5-6-8-10 mm			
96BP/SCV	€ 4,85	🔧 1	📦 000960988

## 96BP-HO/SC9

jogo de 9 chaves sextavadas macho com  
ponta de bola, com sistema de fixação por  
parafuso



96BP-HO/SC9	€ 53,50	🔧 1	📦 000961254
1,5-2-2,5-3-4-5-6-8-10 mm			

## 96LBP

chave sextavada ponta de bola, modelo extra  
longo

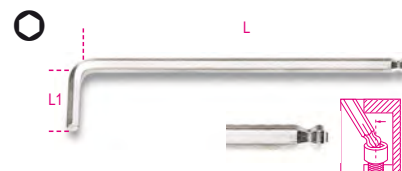

mm	L mm	L1 mm	€	🔧	📦
1,5	90	15	2,90	5	000961340
2	100	17	3,05	5	000961341
2,5	112	20	3,25	5	000961342
3	127	22	3,40	5	000961343
4	144	27	4,15	5	000961344
5	163	32	4,95	5	000961345
6	184	37	6,90	5	000961346
8	204	44	9,50	2	000961348
10	230	49	15,10	2	000961350



96LBP/SC9	€ 58,00	🔧 1	📦 000961354
1,5-2-2,5-3-4-5-6-8-10 mm			
96LBP/SCV	€ 4,85	🔧 1	📦 000961984



## 96BP/AS

chaves macho hexagonal com uma extremidade esférica, brunidas

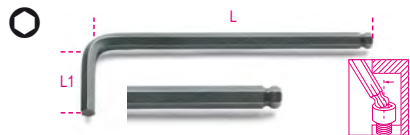

"	L mm	L1 mm	€	🔧	📄
3/32	89	17	2,29	10	000960989
1/8	98	18	2,43	10	000960990
5/32	108	24	2,90	10	000960991
3/16	126	26	3,30	10	000960992
7/32	139	28	4,80	10	000960993
1/4	152	31	5,30	10	000960994
5/16	168	34	7,00	5	000960995
3/8	190	39	11,50	5	000960996



96BP-AS/SC9 1/16-3/32-1/8-5/32-3/16	€ 45,50	🔧 1	📄 000961000
96BP-AS/SCV 7/32-1/4-5/16-3/8	€ 4,85	🔧 1	📄 000961001



96BP-AS/8 3/32-1/8-5/32-3/16-7/32 1/4-5/16-3/8	€ 41,50	🔧 1	📄 000960997
96BP-AS/BV	€ 2,17	🔧 1	📄 000960998

## 96BPA

chave sextavada ponta de bola, 110°, modelo extra curto



mm	L mm	L1 mm	€	🔧	📄
1,5	71	9	2,70	5	000961960
2	86	11	2,84	5	000961961
2,5	96	13	2,95	5	000961962
3	104	15	3,25	5	000961963
4	116	17	3,85	5	000961964
5	132	19	4,65	5	000961965
6	155	21	6,80	5	000961966
8	176	24	8,90	2	000961968
10	200	27	13,90	2	000961970



96BPA/SC9 1,5-2-2,5-3-4-5-6-8-10 mm	€ 54,50	🔧 1	📄 000961974
96BPA/SCV	€ 4,85	🔧 1	📄 000961988

## 96T CHAVES MACHO EXTAVADAS com punho de aperto elevado

Rapidez e facilidade de utilização

O punho de pequenas dimensões é perfeitamente equilibrado, o que lhe permite rodar rapidamente na palma da mão.

O formato ergonómico permite a aplicação de apertos extremamente elevados.

As extremidades sextavadas foram concebidas para transmitir o máximo aperto possível ao parafuso.

O eixo redondo possui uma estrutura homogénea em comparação com o eixo sextavado, o que proporciona força adicional.



O eixo atravessa o punho

## 96T

chaves macho sextavadas com punho

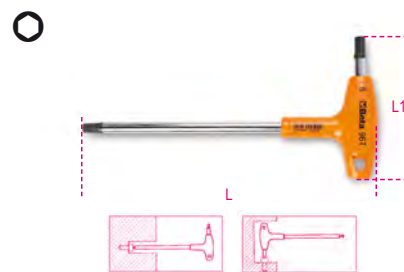

mm	L mm	L1 mm	€	🔧	📄
2	139	52	13,00	5	000960934
2,5	153	55	13,00	5	000960935
3	153	55	13,70	5	000960936
3,5	179	70	14,10	5	000960937
4	179	70	14,10	5	000960938
4,5	200	84	14,40	5	000960939
5	200	84	14,40	5	000960940
6	221	103	16,50	5	000960941
7	236	106	18,10	3	000960942
8	255	117	21,10	3	000960943
10	285	132	24,20	3	000960945



96T/S5P 2,5-3-4-5-6 mm	€ 71,50	🔧 1	📄 000960946
96T/S6 2-2,5-3-4-5-6 mm	€ 84,50	🔧 1	📄 000960952
96T/S8 2-2,5-3-4-5-6-8-10 mm	€ 130,00	🔧 1	📄 000960933
96T/S11 2-2,5-3-3,5-4-4,5-5-6-7-8-10 mm	€ 177,00	🔧 1	📄 000960951



96T/SP11 2-2,5-3-3,5-4-4,5-5 6-7-8-10 mm	€ 220,00	🔧 1	📄 000960957
96T/SPV 96T/S11 97TTX/S11	€ 49,00	🔧 1	📄 000960958

## 96T/AS

chaves macho hexagonal com punho

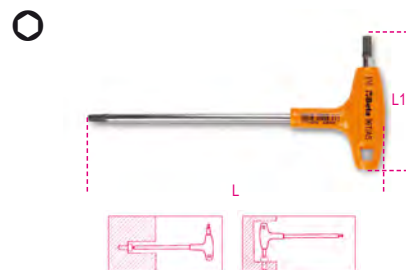

"	L mm	L1 mm	€	🔧	📄
3/32	153	55	16,20	2	000960669
7/64	153	55	16,20	2	000960670
1/8	179	70	16,40	2	000960671
9/64	179	70	17,20	2	000960672
5/32	200	84	17,20	2	000960673
3/16	200	84	17,20	2	000960674
7/32	221	103	19,10	2	000960675
1/4	236	106	21,30	2	000960676
5/16	255	117	24,20	2	000960678
3/8	285	132	29,00	2	000960680



96T/AS8 3/32-7/64-1/8-5/32-3/16- 1/4-5/16-3/8	€ 157,00	🔧 1	📄 000960682
96T/AS10 3/32-7/64-1/8-9/64-5/32 3/16-7/32-1/4-5/16-3/8	€ 194,00	🔧 1	📄 000960683

## 96TBP

chaves macho hexagonal com punho e extremidade esférica



mm	L mm	L1 mm	€	🔧	📄
2,5	153	55	13,70	3	000960685
3	153	55	14,30	3	000960686
4	179	70	15,10	3	000960687
5	200	84	15,70	3	000960688
6	221	103	17,20	3	000960689
8	255	117	22,70	2	000960690
10	285	132	24,20	2	000960692



96TBP/S6	99,00	1	000960694
2,5-3-4-5-6-8 mm			

## 97TX

chaves macho para parafusos com cabeça Torx®



Ø	L mm	L1 mm	€	🔧	📄
T6	42	16	7,30	5	000970006
T7	48	16	7,30	5	000970007
T8	48	16	7,30	5	000970008
T9	48	16	8,00	5	000970009
T10	51	17	8,20	5	000970010
T15	54	18	8,20	5	000970015
T20	57	19	8,70	5	000970020
T25	60	20	8,90	5	000970025
T27	64	21	9,80	5	000970027
T30	70	24	9,80	5	000970030
T40	76	26	10,90	5	000970040
T45	83	29	13,00	5	000970045
T50	95	32	14,90	5	000970050
T55	108	35	18,90	5	000970055
T60	120	38	25,00	5	000970060



97TX/ST8	78,00	1	000970640
T9-T10-T15-T20-T25-T27-T30-T40			



97TX/G8	61,50	1	000970645
T9-T10-T15-T20-T25-T27-T30-T40			



97TX/BG8	48,50	1	000970368
T9-T10-T15-T20-T25-T27-T30-T40			



97TX/SC8	77,00	1	000970064
T9-T10-T15-T20-T25-T27-T30-T40			
97TX/SCV	4,85	1	000970985



97TX/B13	124,00	1	000970650
T6-T7-T8-T9-T10-T15-T20-T25-T27-T30-T40-T45-T50			
96N/BV	2,17	1	000960651

## 97BTX

chaves macho com uma extremidade esférica, para parafusos com cabeça Torx®

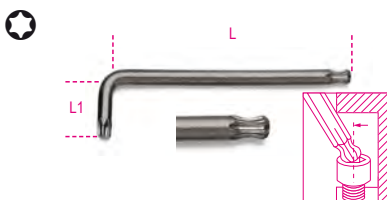

Ø	L mm	L1 mm	€	🔧	📄
T9	62	16	9,30	5	000970109
T10	71	17	9,30	5	000970110
T15	81	18	9,30	5	000970115
T20	92	19	10,00	5	000970120
T25	94	20	10,60	5	000970125
T27	105	21	11,30	5	000970127
T30	114	24	11,40	5	000970130
T40	129	26	13,10	5	000970140
T45	133	28	15,40	5	000970145



97BTX/SC8	89,00	1	000970164
T9-T10-T15-T20-T25-T27-T30-T40			
97BTX/SCV	4,85	1	000970983



97BTX/B8	86,50	1	000970159
T9-T10-T15-T20-T25-T27-T30-T40			
96N/BV	2,17	1	000960651



97BTX-C/SC8	98,50	1	000971658
T9-T10-T15-T20-T25-T27-T30-T40			
97BTX-C/SCV	4,85	1	000971659

## 97BTXL

chaves macho com uma extremidade esférica, para parafusos com cabeça Torx®, modelo longo



Ø	L mm	L1 mm	€	🔧	📄
T9	80	15	9,80	3	000970309
T10	86	17	9,80	3	000970310
T15	100	18	9,80	3	000970315
T20	110	19	11,20	3	000970320
T25	126	20	12,30	3	000970325
T27	140	24	13,80	3	000970327
T30	160	28	14,30	3	000970330
T40	176	32	17,10	3	000970340



97BTXL/SC8	103,00	1	000970364
T9-T10-T15-T20-T25-T27-T30-T40			
97BTXL/SCV	4,85	1	000970982

## 97RTX

chaves macho para parafusos com cabeça Tamper Resistant Torx®



Ø	L mm	L1 mm	€	U	PC
T6	40	15	8,80	5	000970206
T7	45	15	8,80	5	000970207
T8	50	16	8,80	5	000970208
T9	56	16	8,80	5	000970209
T10	62	17	8,80	5	000970210
T15	72	17	8,80	5	000970215
T20	83	18	9,00	5	000970220
T25	90	18	9,30	5	000970225
T27	100	20	10,50	5	000970227
T30	105	24	10,60	5	000970230
T40	112	26	11,60	5	000970240
T45	118	26	13,70	5	000970245
T50	122	28	17,60	3	000970250
T55	128	30	20,20	3	000970255



97RTX/SC8 T9-T10-T15-T20-T25 T27-T30-T40	€ 82,00	U 1	PC 000970263
97RTX/SCV	4,85	U 1	PC 000970984



97RTX/B8 T9-T10-T15-T20-T25 T27-T30-T40	€ 79,50	U 1	PC 000970260
96N/BV	2,17	U 1	PC 000960651

## 97BRTLX/SC8

jogo de 8 chaves sextavadas macho com ponta de bola, modelo longo, para parafusos de perfil Tamper Resistant Torx®



97BRTLX/SC8 T9-T10-T15-T20-T25-T27-T30-T40	€ 104,00	U 1	PC 000970464
97BRTLX/SCV	4,85	U 1	PC 000970986

## 97TTX

chaves duplas macho com punho para parafusos com cabeça Torx®



Ø	L mm	L1 mm	€	U	PC
T6	130	52	13,50	3	000970706
T7	130	52	13,50	3	000970707
T8	139	52	13,60	3	000970708
T9	139	52	13,60	3	000970709
T10	179	70	13,90	3	000970710
T15	179	70	15,00	3	000970715
T20	179	70	15,50	3	000970720
T25	179	70	16,50	3	000970725
T27	200	84	18,10	3	000970727
T30	200	84	18,80	3	000970730
T40	221	103	22,30	3	000970740
T45	236	106	26,00	2	000970745
T50	255	117	33,50	2	000970750



97TTX/S6 T10-T15-T20-T25-T30-T40	€ 102,00	U 1	PC 000970791
97TTX/S8 T8-T10-T15-T20-T25-T27-T30-T40	134,00	U 1	PC 000970808
97TTX/S11 T8-T9-T10-T15-T20-T25-T27-T30-T40-T45-T50	207,00	U 1	PC 000970800
97TTX/S13 T6-T7-T8-T9-T10-T15-T20-T25-T27-T30-T40-T45-T50	233,00	U 1	PC 000970813



97TTX/SP11 T8-T9-T10-T15-T20-T25-T27-T30-T40-T45-T50	€ 250,00	U 1	PC 000970840
96T/SPV 96T/S11 97TTX/S11	49,00	U 1	PC 000960958

## 98XZN

chaves macho hexagonal com perfil XZN®



DIN 65253

Ø	L mm	L1 mm	€	U	PC
M5	83	25	6,30	5	000980005
M6	89	30	7,20	5	000980006
M8	97	32	9,20	5	000980008
M10	106	35	12,00	5	000980010
M12	116	37	15,20	5	000980012



98XZN/B5 M5-M6-M8-M10-M12	€ 52,00	U 1	PC 000980650
96N/BV	2,17	U 1	PC 000960651

## 99

chaves de unha quadrada para porcas com encaixes laterais UNI/ISO 2982, 2983



UNI 6752

Ø mm	A mm	€	U	PC
12-14	1,5	12,10	3	000990012
16-18-20	1,8	12,10	3	000990016
22-25-28	1,8	16,20	3	000990022
30-32	2,1	16,20	3	000990030
34-36-38	2,4	19,70	3	000990034
40-42	2,4	19,70	3	000990040
45-50	2,5	24,40	3	000990045
52-55-58	2,5	24,40	3	000990052
62-65	3,1	30,50	3	000990062
68-70-75	3,1	30,50	3	000990068
80-85-90	3,8	41,00	2	000990080
92-95	4,3	41,00	2	000990092
98-100	4,3	41,00	2	000990098
105-110-115	4,4	65,00	1	000990105
120-125-130	4,9	65,00	1	000990120
135-145	6,0	95,50	1	000990135
155-165	6,0	95,50	1	000990155

## 99SQ

chaves de unha quadrada articulada para porcas com encaixes laterais



Ø mm	S mm	€	U	PC
15-35	5,1	32,50	2	000990215
35-50	6,0	37,00	2	000990235
50-80	8,0	48,50	2	000990250
80-120	8,3	66,50	2	000990280
120-180	10,8	89,00	2	000990290



## 852

porta-bits, com cabo articulado em T

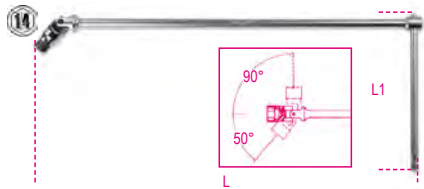

1/4"	L mm 400	L1 mm 160	€ 53,00	2	008520006
------	-------------	--------------	------------	---	-----------

## 855P

punho porta-pontas com roquete reversível, articulado, com 7 bits integrados



L mm 240	L1 mm 100	€ 80,00	1	008550010
-------------	--------------	------------	---	-----------

860PH	PH1 - PH2
860PZ	PZ1 - PZ2
860LP	LP 0,8x5,5 mm
860PE	4 - 5 mm

## 860LP

bits para parafusos ranhurados, coloridos



ISO 2351-1  
ISO 1173 C 6,3

SxA mm	L mm	€	5	008600005
0,5x3	25	2,09	5	008600010
0,6x4,5	25	2,09	5	008600015
0,8x5,5	25	2,09	5	008600020
1x5,5	25	2,09	5	008600025
1,2x6,5	25	2,09	5	

## 860PH

bits para parafusos Phillips®, coloridos

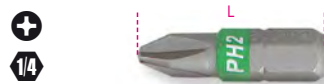

ISO 2351-2  
ISO 1173 C 6,3

PH	L mm	€	5	008600220
0	25	2,09	5	008600225
1	25	2,09	5	008600230
2	25	2,09	5	008600245
3	25	2,09	5	008600250
4	25	3,00	5	

## 860PZ

bits para parafusos Pozidriv® - Supadriv®, coloridos



ISO 2351-2  
ISO 1173 C 6,3

PZ	L mm	€	5	008600320
1	25	2,09	5	008600325
2	25	2,09	5	008600330
3	25	2,09	5	008600335
4	25	3,00	5	

## 860PE

bits sextavados para aparafusadoras eléctricas, coloridos



ISO 2351-3  
ISO 1173 C 6,3

mm	L mm	€	5	008600101
2	25	2,22	5	008600102
2,5	25	2,22	5	008600103
3	25	2,22	5	008600104
4	25	2,22	5	008600105
5	25	2,22	5	008600106
6	25	2,22	5	008600108
8	25	2,79	5	008600110
10	25	2,79	5	

## 860TX

bits para parafusos Torx®, coloridos



ISO 1173 C 6,3

	L mm	€	5	008600704
T6	25	2,79	5	008600705
T7	25	2,79	5	008600710
T8	25	2,79	5	008600715
T9	25	2,79	5	008600720
T10	25	2,22	5	008600725
T15	25	2,22	5	008600730
T20	25	2,22	5	008600735
T25	25	2,22	5	008600740
T27	25	2,22	5	008600745
T30	25	2,22	5	008600750
T40	25	2,22	5	

## 860RTX

bits para parafusos invioláveis Torx®, coloridos



ISO 1173 C 6,3

	L mm	€	5	008600550
T9	25	3,00	5	008600555
T10	25	3,00	5	008600560
T15	25	3,00	5	008600565
T20	25	3,00	5	008600570
T25	25	3,00	5	008600575
T27	25	3,00	5	008600580
T30	25	3,00	5	008600585
T40	25	3,00	5	

## 860/55

chave de bits reversível



L mm 100	1/4	€ 35,50	3	008600870
-------------	-----	------------	---	-----------

## 860/58

roquete com punho rotativo

- O bit encaixa em ambos os lados, para aparafusar ou desaparafusar
- Punho bi-material



L mm 126	1/4"	Ø mm 27	A mm 15	€ 82,00	1	008600884
-------------	------	------------	------------	------------	---	-----------

## 860/C27

jogo de 25 bits, 1 conector e 1 roquete reversível em estojo de plástico



860/C27	€ 97,00	1	008600880
---------	------------	---	-----------

860/55	100 mm
860LP	0,5x3-1,0x5,5-1,2x6,5 mm
860PH	PH1-PH2(x2)-PH3
860PZ	PZ1-PZ2(x2)-PZ3
860PE	2-2,5-3-4-5-6 mm
860TX	T6-T8-T10-T15-T20-T25-T30-T40
892/0	1/4 1/4



## 860/C38P

1 punho porta-pontas com roquete reversível,  
27 bits, 8 chaves de caixa sextavadas e 2  
acessórios  
em estojo de metal com tabuleiro maleável

porta-pontas com roquete reversível  
tampa porta-bits  
barra de extensão amovível de montagem rápida



860/C38P € 210,00 1 008600878

	860LP	0,6x4,5-0,8x5,5-1,0x5,5-1,2x6,5 mm
	860PE	2-2,5-3-4-5 mm
	860PH	PH1-PH2-PH3
	860PZ	PZ1-PZ2-PZ3
	860TX	T10-T15-T20-T25-T30-T40
	900	5-5,5-6-7-8-9-10-13 mm
	892/0	● 1/4 ■ 1/4
	892/3	● 1/4 ■ 1/4
	855P	240 mm
270x120x45 mm		

## 861LP

pontas para parafusos de fenda



ISO 2351-1

ISO 1173 C 6,3

SxA mm	L mm	€	10	008610005
0,5x3	25	1,35	10	008610005
0,6x4	25	1,35	10	008610007
0,6x4,5	25	1,35	10	008610010
0,8x5,5	25	1,35	10	008610015
1x5,5	25	1,35	10	008610020
1,2x6,5	25	1,35	10	008610025
1,2x8	25	2,59	10	008610028
1,6x8	25	2,59	10	008610030

## 861PH

pontas para parafusos de perfil Phillips(R)



ISO 2351-2

ISO 1173 C 6,3

PH	L mm	€	10	008610200
0	25	1,33	10	008610200
1	25	1,33	10	008610205
2	25	1,33	10	008610210
2L	50	2,59	10	008610213
3	25	1,33	10	008610215
4	25	3,55	10	008610220

## 861PH/C

pontas para parafusos de perfil Phillips®

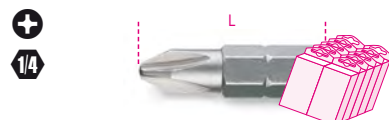

ISO 2351-2

ISO 1173 C 6,3

PH	L mm	€	200	008610250
0	25	1,01	200	008610250
1	25	1,01	200	008610255
2	25	1,01	200	008610260
2L	50	1,95	100	008610263
3	25	1,01	200	008610265
4	25	2,63	100	008610270

## 861PZ

pontas para parafusos  
de perfil Pozidriv(R) - Supadriv(R)



ISO 2351-2

ISO 1173 C 6,3

PZ	L mm	€	10	008610300
1	25	1,33	10	008610300
2	25	1,33	10	008610305
2L	50	2,56	10	008610308
3	25	1,33	10	008610310
4	25	3,55	10	008610315

## 861PZ/C

pontas para parafusos  
de perfil Pozidriv® - Supadriv®



ISO 2351-2

ISO 1173 C 6,3

PZ	L mm	€	200	008610350
1	25	1,01	200	008610350
2	25	1,01	200	008610355
2L	50	1,95	100	008610358
3	25	1,01	200	008610360
4	25	2,59	100	008610365

## 861PE

pontas macho hexagonal



ISO 2351-3

ISO 1173 C 6,3

mm	L mm	€	10	008610100
2	25	1,43	10	008610100
2,5	25	1,43	10	008610105
3	25	1,43	10	008610110
4	25	1,43	10	008610115
5	25	1,43	10	008610120
6	25	1,43	10	008610125
8	25	2,15	10	008610130
10	25	2,84	10	008610135

## 861TX

pontas para parafusos  
de perfil Torx®



ISO 1173 C 6,3

T	L mm	€	10	008610399
T5	25	1,89	10	008610399
T6	25	1,89	10	008610400
T7	25	1,89	10	008610405
T8	25	1,89	10	008610410
T9	25	1,89	10	008610415
T10	25	1,49	10	008610420
T15	25	1,49	10	008610425
T20	25	1,49	10	008610430
T25	25	1,49	10	008610435
T27	25	1,49	10	008610440
T30	25	1,49	10	008610445
T40	25	1,49	10	008610450

## 861TX/C

pontas para parafusos  
de perfil Torx®



ISO 1173 C 6,3

T	L mm	€	200	008610470
T10	25	1,15	200	008610470
T15	25	1,15	200	008610475
T20	25	1,15	200	008610480
T25	25	1,15	200	008610485
T27	25	1,15	200	008610490
T30	25	1,15	200	008610495
T40	25	1,15	200	008610499

## 861RTX

pontas para parafusos  
de perfil Tamper Resistant Torx(R)

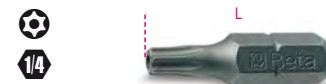

ISO 1173 C 6,3

T	L mm	€	10	008610537
T6	25	2,79	10	008610537
T7	25	2,79	10	008610538
T8	25	2,79	10	008610540
T9	25	2,79	10	008610500
T10	25	2,79	10	008610505
T15	25	2,79	10	008610510
T20	25	2,79	10	008610515
T25	25	2,79	10	008610520
T27	25	2,79	10	008610525
T30	25	2,79	10	008610530
T40	25	2,79	10	008610535
T45	25	5,50	10	008610539



## 861TRW

pontas para parafusos de perfil Tri-Wing(R)



ISO 1173 C 6,3

GR	L mm	€		
1	25	2,37	10	008610601
2	25	2,37	10	008610602
3	25	2,37	10	008610603
4	25	2,37	10	008610604
5	25	2,37	10	008610605
6	25	3,45	10	008610606

## 861TQS

pontas para parafusos de perfil Torq-Set(R)



ISO 1173 C 6,3

GR	L mm	€		
0	25	2,37	10	008610620
1	25	2,37	10	008610621
2	25	2,37	10	008610622
3	25	2,37	10	008610623
4	25	2,37	10	008610624
5	25	2,37	10	008610625
6	25	2,37	10	008610626
8	25	2,37	10	008610628
10	25	2,37	10	008610630

## 861SP

pontas para parafusos de perfil Spanner



ISO 1173 C 6,3

SP	D mm	L mm	€		
4	1,5	25	1,95	10	008610650
6	2,4	25	1,95	10	008610653
8	2,8	25	1,95	10	008610656
10	3,3	25	1,95	10	008610658
12	3,9	25	1,95	10	008610660

## 1483KV-PT/S7



1483KV PT/S7

180



## 861PHZ/A10

jogo de 10 bits com porta-bits magnético, em estojo de bolso



861PHZ/A10

€ 32,50

1 008610810

861PH	PH1 PH2 PH3	1 3 1
861PZ	PZ1 PZ2 PZ3	1 3 1
882M1	○ 1/4 ● 1/4	

## 861PE/A10

jogo de 10 bits com porta-bits magnético, em estojo de bolso



861PE/A10

€ 34,00

1 008610820

861PE	2 - 2,5 3 - 4 - 5 6 - 8 mm	1 2 1
882M1	○ 1/4 ● 1/4	

## 861TX/A10

jogo de 10 bits com porta-bits magnético, em estojo de bolso



861TX/A10

€ 35,00

1 008610870

861TX	T7 - T8 - T9 - T10 - T15 - T20 T25 - T27 - T30 - T40	1
882M1	○ 1/4 ● 1/4	

## 861MIX/A10

jogo de 10 bits com porta-bits magnético, em estojo de bolso



861MIX/A10

€ 32,50

1 008610800

861LP	0,5x3 - 1x5,5 x 1,2x6,5 mm	1
861PH	PH1 PH2 PH3	1 2 1
861PZ	PZ1 - PZ2 - PZ3	1
882M1	○ 1/4 ● 1/4	

## 861MIX/A31

jogo de 30 bits com porta-bits magnético de desengate rápido, em estojo de bolso



861MIX/A31

€ 80,00

1 008610802

861LP	0,5x3 - 0,6x4,5 - 0,8x5,5 - 1,0x5,5 - 1,2x6,5 mm	
861PH	PH0 - PH1 - PH2 - PH3 - PH4	
861PE	2 - 2,5 - 3 - 4 - 5 - 6 8 - 10 mm	
861PZ	PZ1 - PZ2 - PZ3 - PZ4	
861RTX	T9 - T10 - T15 - T20 - T25 T27 - T30 - T40	
882MSR 50	○ 1/4 ● 1/4	



## 861/C61P

61 pontas e 1 porta-pontas magnético de desengate rápido com punho

1/4



861/C61P € 182,00 1 008610978

- 861LP 0,5x3 - 0,6x4,5 - 0,8x5,5 - 1,0x5,5 - 1,2x6,5 - 1,2x8 - 1,6x8 mm
  - 861PE 2 - 2,5 - 3 - 4 - 5 - 6 - 8 - 10 mm
  - 861PH PH0 - PH1 - PH2 - PH3
  - 861PZ PZ1 - PZ2 - PZ3
  - 861TX T6 - T7 - T8 - T9 - T10 - T15 - T20 - T25 - T27 - T30 - T40
  - 861RTX T9 - T10 - T15 - T20 - T25 - T27 - T30 - T40
  - 861TRW 1 - 2 - 3 - 4 - 5 - 6
  - 861TQS 0 - 1 - 2 - 3 - 4 - 5 - 6 - 8 - 10
  - 861SP 4 - 6 - 8 - 10 - 12
  - 851SR 1/4"
- 270x120x45 mm - 975 g

## 862LP

pontas para parafusos de perfil de fenda



ISO 2351-1

ISO 1173 E 6,3

SxA mm	L mm	€	5	10
0,5x3	50	3,90	5	008620005
0,6x4,5	50	3,90	5	008620010
0,8x5,5	50	3,90	5	008620015
1x5,5	50	3,90	5	008620020
1,2x6,5	50	3,90	5	008620025
1,2x8	50	4,80	5	008620030
1,6x8	50	4,80	5	008620035

## 862PH

pontas para parafusos de perfil Phillips®



ISO 2351-2

ISO 1173 E 6,3

PH	L mm	€	5	10
1	50	3,90	5	008620200
2	50	3,90	5	008620205
3	50	3,90	5	008620210

## 862PH/L

pontas para parafusos de perfil Phillips®



ISO 2351-2

ISO 1173 E 6,3

PH	L mm	€	5	10
1	70	7,20	5	008620230
2	70	7,20	5	008620232
3	70	7,20	5	008620234

## 862PH-XL

Pontas para parafusos de perfil Phillips®



ISO 2351-2 ISO 1173 E 6,3

PH	L mm	€	5	10
1	100	7,40	5	008620250
2	100	7,40	5	008620252
3	100	7,40	5	008620254

## 862PZ

pontas para parafusos de perfil Pozidriv® - Supadriv®



ISO 2351-2

ISO 1173 E 6,3

PZ	L mm	€	5	10
1	50	4,00	5	008620300
2	50	4,00	5	008620305
3	50	4,00	5	008620310

## 862PE

pontas macho hexagonal



ISO 2351-3

ISO 1173 E 6,3

mm	L mm	€	5	10
3	50	4,00	5	008620103
4	50	4,00	5	008620104
5	50	4,00	5	008620105
6	50	4,00	5	008620106
8	50	5,50	5	008620108

## 862TX

pontas para parafusos de perfil Torx®



ISO 1173 E 6,3

T	L mm	€	5	10
T6	50	5,40	5	008620506
T7	50	5,40	5	008620507
T8	50	5,40	5	008620508
T9	50	5,40	5	008620509
T10	50	5,40	5	008620510
T15	50	5,40	5	008620515
T20	50	5,40	5	008620520
T25	50	5,40	5	008620525
T27	50	5,40	5	008620527
T30	50	5,40	5	008620530
T40	50	5,40	5	008620540

## 862TX/L

pontas para parafusos de perfil Torx®



ISO 1173 E 6,3

T	L mm	€	5	10
T6	70	5,80	5	008620556
T7	70	5,80	5	008620557
T8	70	5,80	5	008620558
T9	70	5,80	5	008620559
T10	70	5,80	5	008620560
T15	70	5,80	5	008620565
T20	70	5,80	5	008620570
T25	70	5,80	5	008620575
T27	70	5,80	5	008620577
T30	70	5,80	5	008620580
T40	70	5,80	5	008620590

## 862TX-XL

Pontas para parafusos de perfil Torx®



ISO 1173 E 6,3

T	L mm	€	5	10
T9	100	6,40	5	008620659
T10	100	6,40	5	008620660
T15	100	6,40	5	008620665
T20	100	6,40	5	008620670
T25	100	6,40	5	008620675
T27	100	6,40	5	008620677
T30	100	6,40	5	008620680
T40	100	6,40	5	008620690



## 862F

pontas para chaves de caixa magnéticas



ISO 1173 E 6,3

mm	L mm	Ø mm	€	📦	🖨️
5,5	65	11	7,30	5	008620405
6	65	11	7,30	5	008620406
7	65	11	7,30	5	008620407
8	65	13	7,30	5	008620408
10	65	15	8,00	5	008620410
12	65	18	8,80	5	008620412
13	65	18	9,30	5	008620413

## 862F/A7

Jogo de 7 bits sextavados magnéticos com chaves de caixa sextavadas em estojo de plástico



862F/A7 € 55,50 📦 1 🖨️ 008620950

862F 5,5-6-7-8-10-12-13 mm

## 862XP/A16

16 pontas de impacto em estojo de bolso



862XP/A16 € 73,50 📦 1 🖨️ 008620960

- ⊕ PH2(x2)-PH3
- ⊕ PZ2(x2)-PZ3
- ⊖ T20-T25(x2)
- ⊖ T30(x2)-T40(x2)
- 4-5-6 mm

## 866LP

pontas para parafusos de fendas



ISO 2351-1  
ISO 1173 C 8

SxA mm	L mm	€	📦	🖨️
1x5,5	41	4,00	10	008660005
1,2x6,5	41	4,00	10	008660010
1,6x8	41	4,00	10	008660015
1,6x10	41	5,50	10	008660020
2x12	41	6,80	10	008660025

## 866PH

pontas para parafusos de perfil Phillips®



ISO 2351-2  
ISO 1173 C 8

PH	L mm	€	📦	🖨️
1	32	3,25	10	008660200
2	32	3,25	10	008660205
3	32	3,25	10	008660210
4	38	4,85	10	008660215

## 866PZ

pontas para parafusos de perfil Pozidriv® - Supadriv®



ISO 2351-2  
ISO 1173 C 8

PZ	L mm	€	📦	🖨️
1	32	3,40	10	008660300
2	32	3,40	10	008660305
3	32	3,40	10	008660310
4	38	5,10	10	008660315

## 866PE

pontas macho hexagonal



ISO 2351-3  
ISO 1173 C 8

mm	L mm	€	📦	🖨️
3	30	2,79	10	008660100
4	30	2,79	10	008660105
5	30	2,79	10	008660110
6	30	2,79	10	008660115
7	30	2,79	10	008660117
8	30	2,79	10	008660120
10	30	3,90	10	008660125
12	30	5,50	10	008660132
14	30	7,00	10	008660134

## 866TX

pontas para parafusos de perfil Torx®



ISO 1173 C 8

T	L mm	€	📦	🖨️
T20	30	3,50	10	008660400
T25	30	3,50	10	008660405
T27	30	3,50	10	008660410
T30	30	3,50	10	008660415
T40	30	3,50	10	008660420
T45	30	3,50	10	008660425
T50	30	3,50	10	008660430
T55	30	5,10	10	008660435
T60	30	6,80	10	008660440
T70	30	7,50	10	008660445

## 867PE

pontas macho hexagonal



mm	L mm	€	📦	🖨️
4	30	1,83	5	008670104
5	30	1,83	5	008670105
6	30	1,83	5	008670106
7	30	1,83	5	008670107
8	30	1,83	5	008670108
10	30	1,83	5	008670110
12	30	2,72	5	008670112

## 867PE/L

pontas hexagonais



mm	L mm	€	📦	🖨️
4	75	3,40	5	008670154
5	75	3,40	5	008670155
6	75	3,40	5	008670156
7	75	3,40	5	008670157
8	75	3,40	5	008670158
10	75	3,40	5	008670160
12	75	4,75	5	008670162

## 867XZN

pontas para parafusos de perfil XZN(R)



M	L mm	€	📦	🖨️
M4	30	2,29	5	008670204
M5	30	2,29	5	008670205
M6	30	2,29	5	008670206
M8	30	2,29	5	008670208
M10	30	2,29	5	008670210
M12	30	3,40	5	008670212

## 867XZN/L

pontas com perfil XZN(R)



Ø	L mm	€	5	10	15
M5	75	3,70	5	008670255	
M6	75	3,70	5	008670256	
M8	75	3,70	5	008670258	
M10	75	3,70	5	008670260	
M12	75	5,10	5	008670262	

## 867TX

pontas para parafusos de perfil Torx(R)



Ø	L mm	€	5	10	15
T20	30	1,83	5	008670400	
T25	30	1,83	5	008670405	
T30	30	1,83	5	008670410	
T40	30	1,83	5	008670415	
T45	30	1,83	5	008670420	
T50	30	1,83	5	008670425	
T55	30	1,83	5	008670430	

## 867TX/L

pontas para parafusos de perfil Torx(R)



Ø	L mm	€	5	10	15
T20	75	2,99	5	008670450	
T25	75	2,99	5	008670455	
T30	75	2,99	5	008670460	
T40	75	2,99	5	008670465	
T45	75	2,99	5	008670470	
T50	75	2,99	5	008670475	
T55	75	2,99	5	008670480	

## 867RTX

pontas para parafusos de perfil Tamper Resistant Torx(R)



Ø	L mm	€	5	10	15
T20	30	2,04	5	008670500	
T25	30	2,04	5	008670505	
T30	30	2,04	5	008670510	
T40	30	2,04	5	008670515	
T45	30	2,04	5	008670520	
T50	30	2,04	5	008670525	
T55	30	2,04	5	008670530	

## 867RTX/L

pontas para parafusos de perfil Tamper Resistant Torx®



Ø	L mm	€	5	10	15
T20	75	3,40	5	008670550	
T25	75	3,40	5	008670555	
T30	75	3,40	5	008670560	
T40	75	3,40	5	008670565	
T45	75	3,40	5	008670570	
T50	75	3,40	5	008670575	
T55	75	3,40	5	008670580	

## 867RIBE

pontas para parafusos RIBE®



Ø	L mm	€	5	10	15
M5	30	2,09	5	008670705	
M6	30	2,09	5	008670706	
M7	30	2,09	5	008670707	
M8	30	2,09	5	008670708	
M9	30	2,09	5	008670709	
M10	30	2,09	5	008670710	
M11	30	3,05	5	008670711	
M12	30	3,05	5	008670712	
M13	30	3,05	5	008670713	

## 867RIBE/L

pontas para parafusos de perfil RIBE®



Ø	L mm	€	5	10	15
M5	75	3,40	5	008670755	
M6	75	3,40	5	008670756	
M7	75	3,40	5	008670757	
M8	75	3,40	5	008670758	
M9	75	3,40	5	008670759	
M10	75	3,40	5	008670760	
M11	75	4,60	5	008670761	
M12	75	4,60	5	008670762	
M13	75	4,60	5	008670763	

## 867/...

chaves de caixa porta-pontas para artigos 867



Ø	L mm	Ø	€	5	10	15
867/1	10	3/8"	38	17	6,60	5 008670600
867/2	10	1/2"	38	22	7,40	5 008670601

## 867/C20

jogo 18 bits para parafusos RIBE®, com encabadouro sextavado 10 mm e 2 acessórios



867/C20	€	5	10	15
	130,00	1	008670920	

867RIBE	5-6-7-8-9-10-11-12-13 mm
867RIBE/L	5-6-7-8-9-10-11-12-13 mm
867/1	
867/2	
335x145x60 mm - 1,7 kg	

## 867/C38

Porta Bits com punho em T articulado, 38 sextavados 10 mm



867/C38	€	5	10	15
	239,00	1	008670938	

852	10 mm
867PE	4-5-6-7-8-10-12mm
867PE/L	4-5-6-7-8-10-12mm
867XZN	M5-M6-M8-M10-M12
867XZN/L	M5-M6-M8-M10-M12
867TX	T20-T25-T30-T40-T45-T50-T55
867TX/L	T20-T25-T30-T40-T45-T50-T55
882	
420x185x60 mm - 3 kg	



# Beta

## 867/C52

jogo com 52 pontas,  
com porta-pontas hexagonal de 10 mm  
e 2 acessórios



867/C52 € 148,00 1 008670901

	○ 867PE	4-5-6-7-8-10-12 mm
	○ 867PE/L	4-5-6-7-8-10-12 mm
	○ 867XZN	M5-M6-M8-M10-M12
	○ 867XZN/L	M5-M6-M8-M10-M12
	⊕ 867TX	T20-T25-T30-T40-T45-T50-T55
	⊕ 867TX/L	T20-T25-T30-T40-T45-T50-T55
	⊕ 867RTX	T20-T25-T30-T40-T45-T50-T55
	⊕ 867RTX/L	T20-T25-T30-T40-T45-T50-T55
	867/1	○ 10 mm - □ 3/8"
	867/2	○ 10 mm - □ 1/2"

250x170x70 mm - 2,1 kg

## 852



852 1/4 79,117

## 882

porta-pontas com anel de retenção  
para aparafusadoras



ISO 1173 E 6,3

L mm 57 1/4 1/4 11 € 18,30 5 008820001

## 882AN

caixa de velocidades, encabadouro sextavado  
1/4"

- Para berbequins com veio 10 mm e 13 mm e chaves de impacto 1/4"
- Velocidade máx.: 3600 rpm
- Binário máx.: 30 Nm
- Porta-pontas com substituição rápida
- Relação: 1:1
- Ligação à ferramenta através de encabadouro sextavado 1/4" D6.3



ISO 1173 E 6,3  
ISO 1173 C 6,3

L mm 137 1/4 1/4 11 € 79,00 1 008820090

## 882M1

porta-pontas magnético



ISO 1173 E 6,3

L mm 50 1/4 1/4 11 € 19,30 5 008820006

## 882M

porta-pontas magnético



ISO 1173 E 6,3

L mm 75 1/4 1/4 11 € 23,30 5 008820005

## 882MSR

porta-pontas magnético com desengate rápido  
para aparafusadoras



ISO 1173 E 6,3

L mm 50 1/4 1/4 11 € 20,80 5 008820205  
75 1/4 1/4 11 € 24,30 5 008820207

## 882P

extensão para porta-bits magnético



L mm 80 1/4 1/4 10 € 17,00 5 008820080



## 892

adaptadores para aparafusadoras



	□	●	L mm	€		
892/0	1/4	1/4	25	6,00	5	008920000
* 892/1	1/4	5,5	50	11,40	5	008920001
* 892/2	3/8	5,5	50	16,90	5	008920002
* 892/3	1/4	1/4	50	11,40	5	008920003
* 892/4	3/8	1/4	50	16,90	5	008920004
892/5	1/4	5/16	75	15,70	5	008920005
892/6	3/8	5/16	75	23,00	5	008920006
892/7	1/2	1/4	75	23,80	5	008920007

\* ISO 1173 A 5,5  
° ISO 1173 C 6,3

## 895

chaves de caixa porta-pontas  
refª s. 861 - 862 - 866



DIN 7427

	○	□	L mm	Ø mm	€	
895/1	1/4	1/4	25,4	12	13,70	5 008950000
895/3	1/4	3/8	29	16,8	16,30	5 008950001
895/4	5/16	3/8	29	16,8	16,30	5 008950002
895/5	1/4	1/2	38	22	16,30	5 008950005
895/6	5/16	1/2	38	22	16,30	5 008950003

## 897

porta-pontas flexível com punho



L mm 280 L1 mm 154 € 31,00 2 008970010

## 897L

porta-pontas flexível com punho,  
modelo longo



L mm 500 L1 mm 380 € 35,50 2 008970015



<b>949/S6</b>	€ 226,00	1	009490076
8-10-12-13-14-17mm			

## 950

chaves de caixa simples hexagonal com punho em T

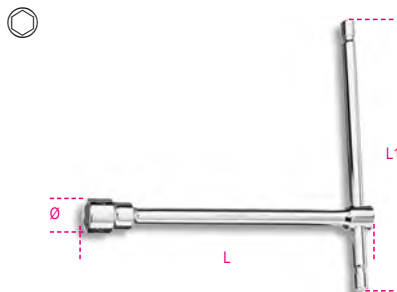

UNI 6742 DIN 3112

mm	L	Ø	L1	€		
6	210	10,1	145	23,00	3	009500006
7	212	11,2	145	23,00	3	009500007
8	220	12,4	160	24,80	3	009500008
9	223	13,5	160	24,80	3	009500009
10	230	14,9	160	27,00	3	009500010
11	233	16,1	160	27,00	3	009500011
12	240	17,5	175	29,50	3	009500012
13	244	19,7	175	29,50	3	009500013
14	250	20,1	190	33,50	3	009500014
15	254	21,5	190	35,00	3	009500015
16	260	22,7	200	38,00	3	009500016
17	264	24,1	200	39,50	3	009500017
19	274	26,6	230	48,50	3	009500019
22	290	29,9	290	58,50	2	009500022
24	300	32,2	320	66,00	2	009500024
27	315	36,2	370	78,00	2	009500027



<b>950/S9</b>	€ 282,00	1	009500079
7-8-10-11-12 13-14-17-19 mm			
<b>950/S14</b>	€ 460,00	1	009500082
6-7-8-9-10-11-12-13 14-15-16-17-19-22 mm			

# 951 CHAVES COM PUNHO EM T E TRÊS MACHOS SEXTAVADOS

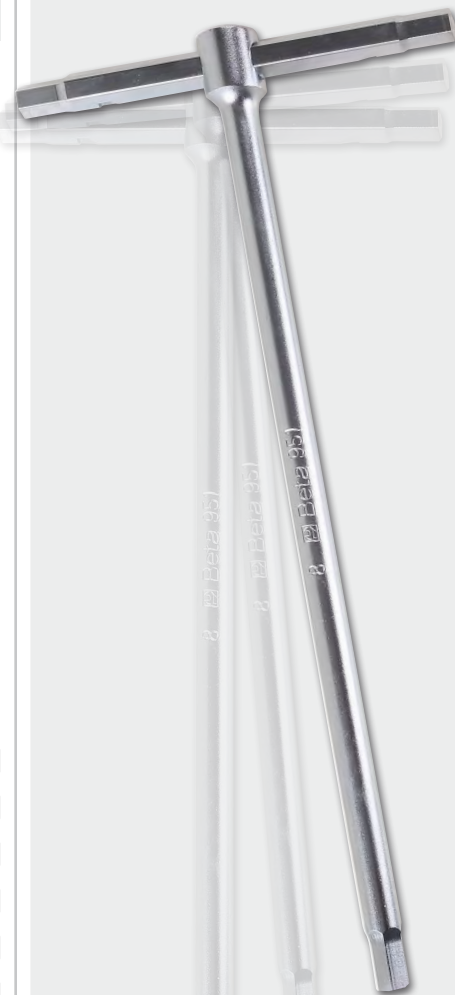

Quando a Beta lançou esta chave, em 1980, foi uma revolução. Concebida para parafusos de alta resistência, é sinónimo de manuseamento rápido, encaixe preciso e utilização versátil. Regulação livre do punho sextavado em T. Extremidades sextavadas desenhadas para transmissão da máxima força possível ao parafuso.

A sua extensão permite a aplicação de apertos extraordinários aos parafusos. Constantes melhorias na produção traduziram-se, por exemplo, em acabamentos com jato de areia e extremidades sextavadas de arestas afiadas que garantem um melhor encaixe em quaisquer parafusos, mesmo nos danificados. A marcação a laser resulta num punho mais resistente. A marcação a laser torna a haste mais resistente.

O novo modelo, 951GP, foi desenvolvido em conjunto com técnicos e mecânicos de MotoGP e Superbike, com o objetivo de aumentar a velocidade de aparafusar/desaparafusar.

## 951

chaves em T com macho hexagonal articulado



mm	L	L1	Ø	€		
2	125	63	4,0	21,10	5	009510521
2,5	150	63	4,0	21,10	5	009510525
3	150	63	4,0	21,10	5	009510530
3,5	175	76	5,5	21,70	5	009510535
4	175	76	5,5	21,70	5	009510540
4,5	195	87	6,5	23,80	5	009510545
5	195	87	6,5	23,80	5	009510550
6	215	99	8,0	27,50	5	009510560
7	230	109	9,0	29,50	5	009510570
8	250	122	10,0	29,50	5	009510580
9	265	132	11,0	37,00	5	009510590
10	280	142	12,0	37,00	5	009510610
12	305	160	15,0	50,50	3	009510620
14	330	178	17,0	60,00	3	009510640

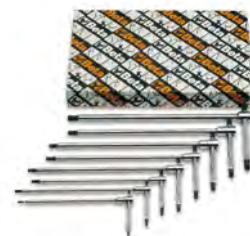

<b>951/S6</b>	€ 145,00	1	009510687
2,5-3-4-5-6-8 mm			
<b>951/S8</b>	€ 182,00	1	009510693
2-2,5-3-3,5-4-4,5-5-6 mm			
<b>951/S14</b>	€ 425,00	1	009510695
2-2,5-3-3,5-4-4,5 5-6-7-8-9-10-12-14 mm			



<b>951/SP6</b>	€ 185,00	1	009510696
3-4-5-6-8-10 mm			
<b>951/SPV</b>	€ 34,00	1	009510697



## 951AS

chaves em T com macho hexagonal, articulado

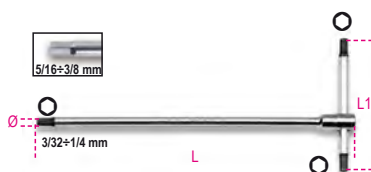

"	L mm	L1 mm	Ø mm	€	🔧	📦
3/32	125	63	4,0	28,50	2	009510750
7/64	150	63	4,0	28,50	2	009510751
1/8	150	63	4,0	28,50	2	009510752
9/64	175	76	5,5	29,50	2	009510753
5/32	175	76	5,5	29,50	2	009510754
3/16	195	86	6,5	32,00	2	009510755
7/32	215	99	8,0	32,00	2	009510757
1/4	230	109	9,0	36,50	2	009510758
5/16	250	122	10,0	37,00	2	009510759
3/8	280	142	12,0	45,50	2	009510760



951AS/S6X 212,00 € 1 009510771  
1/8-3/16-7/32-1/4-5/16-3/8

## 951GP

chave em T com macho sextavado

A chave Beta 951GP é sinónimo de um ajuste rápido e preciso.

Concebida para satisfazer alguns requisitos importantes do mundo das corridas: desenvolver valores de binário elevados e garantir um aperto rápido.

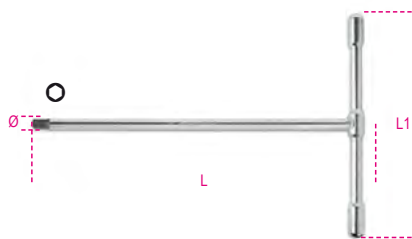

mm	L mm	L1 mm	Ø	€	🔧	📦
3	185	130	5	20,80	3	009511530
4	214	150	5	21,80	3	009511540
5	240	165	6	25,00	3	009511550
6	271	180	7	29,00	3	009511560
8	300	200	10	37,00	3	009511580
10	310	200	12	46,00	3	009511610



951GP/S6 180,00 € 1 009511687  
3-4-5-6-8-10 mm

## 951TX

chaves em T com pontas para parafusos de perfil Torx®, articulado

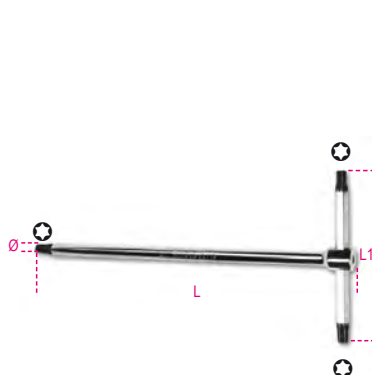

Ø	L mm	L1 mm	Ø mm	€	🔧	📦
T6	125	63	4	26,00	3	009510806
T7	125	63	4	26,00	3	009510807
T8	125	63	4	27,00	3	009510808
T9	125	63	4	27,00	3	009510809
T10	150	63	4	27,50	3	009510810
T15	150	63	4	27,50	3	009510815
T20	175	76	5	29,00	3	009510820
T25	175	76	5	29,00	3	009510825
T27	195	87	6	30,50	3	009510827
T30	195	87	6	30,50	3	009510830
T40	215	99	7	35,50	3	009510840
T45	230	109	8	37,50	3	009510845
T50	250	122	9	40,50	3	009510850

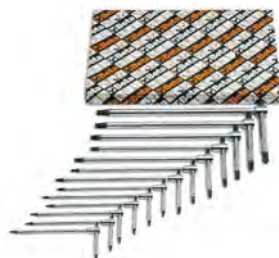

951TX/S6 170,00 € 1 009510866  
T8-T10-T15-T20-T25-T30  
951TX/S13 393,00 € 1 009510863  
T6-T7-T8-T9-T10-T15-T20-T25  
T27-T30-T40-T45-T50



# Beta

## 952 CHAVES DE CAIXA COM CARDAN E CABO EM T EM T

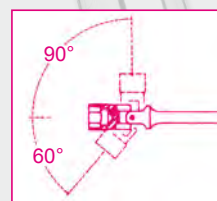

O segredo do sucesso desta chave é o pré-posicionamento preciso e fiável.

A junta articulada mantém a sua função ao longo dos anos, sem necessidade de ajustes. Ângulo de rotação: 60°.

Possibilidade de utilização a 90° em posição fixa. Cabo em T deslizante, com possibilidade de bloqueio em qualquer posição ao longo de toda a extensão.

Marcação de três tamanhos na cabeça.

## 952

chaves de caixa hexagonais com cardam e cabo em T

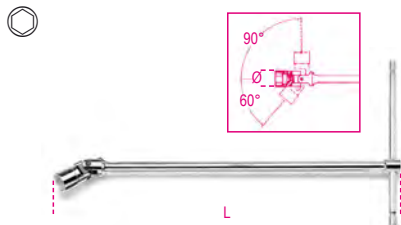

UNI 6743

mm	Ø mm	L mm	€		
6	9,5	395	35,50	5	009520006
7	10,7	395	35,50	5	009520007
8	12,1	395	35,50	5	009520008
9	13,2	395	35,50	5	009520009
10	14,6	400	38,00	5	009520010
11	15,8	400	38,00	5	009520011
12	17,0	400	38,00	5	009520012
13	18,7	432	41,00	5	009520013
14	19,7	432	41,00	5	009520014
15	20,9	450	50,50	3	009520015
16	22,0	450	50,50	3	009520016
17	23,4	450	50,50	3	009520017
18	24,7	450	50,50	3	009520018
19	26,0	500	61,50	3	009520019
20	27,4	500	61,50	3	009520020
21	28,5	500	61,50	3	009520021
22	29,7	500	61,50	3	009520022
24	32,4	500	61,50	3	009520024



<b>952/S7</b> 8-10-11-13-14-17-19 mm	<b>305,00</b>	1	009520074
<b>952/S10</b> 7-8-10-11-12-13-14-15-17-19 mm	<b>429,00</b>	1	009520080
<b>952/S18</b> 6-7-8-9-10-11-12-13-14-15-16-17-18-19-20-21-22-24 mm	<b>845,00</b>	1	009520083



<b>952/D7</b> 7-8-10-12-13-14-17 mm	<b>280,00</b>	1	009520079
--	---------------	---	-----------

## 852



852 1/4

79,85

## 952AS

chaves de caixa hexagonais com cardan e cabo em T

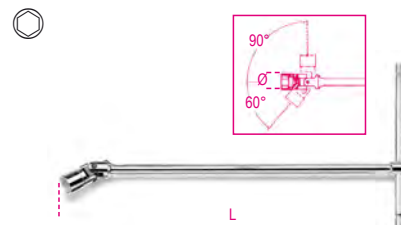

"	Ø mm	L mm	€		
1/4	9,5	395	38,50	2	009520256
5/16	12,1	395	38,50	2	009520258
3/8	14,6	400	41,50	2	009520260
7/16	15,8	400	41,50	2	009520261
1/2	18,7	432	47,00	2	009520263
9/16	19,7	432	50,50	2	009520264
5/8	22,0	450	53,50	2	009520266
11/16	23,4	450	53,50	2	009520267
3/4	26,0	500	66,50	2	009520269

## 952L

chaves de caixa hexagonais com cardan e cabo em T série longa

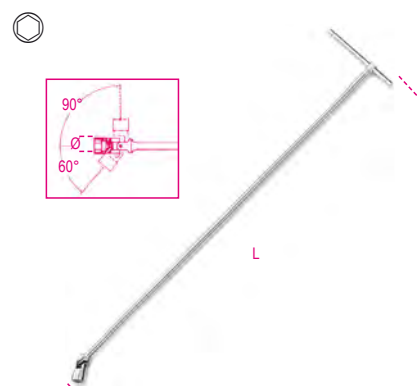

mm	Ø mm	L mm	€		
10	14,6	930	97,50	1	009520410
12	17,0	1063	97,50	1	009520412
13	18,7	1100	97,50	1	009520413
14	19,7	1100	97,50	1	009520414
15	20,9	1100	109,00	1	009520415
16	22,0	1100	109,00	1	009520416
17	23,4	1100	109,00	1	009520417
18	24,7	1100	109,00	1	009520418
19	26,0	1100	127,00	1	009520419

## 952FTX

chaves de caixa com cardan e cabo em T, para parafusos com perfil Torx®

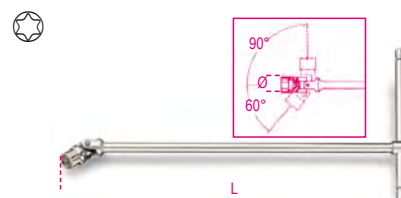

Ø mm	L mm	€			
E6	8	392	41,50	2	009520106
E7	9	392	41,50	2	009520107
E8	10	395	48,00	2	009520108
E10	13	400	49,00	2	009520110
E12	15	440	59,00	2	009520112
E14	17	490	72,00	2	009520114
E16	19	490	72,00	2	009520116
E18	21	490	72,00	2	009520118
E20	23	490	72,00	2	009520120



<b>952FTX/S9</b> E6-E7-E8-E10-E12 E14-E16-E18-E20	<b>530,00</b>	1	009520141
---	---------------	---	-----------

## 953

chaves em T com macho hexagonal articulado

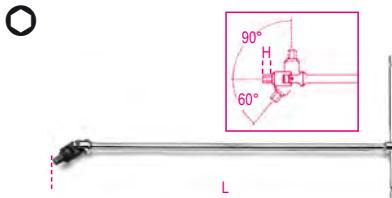

UNI 6754

mm	H mm	L mm	€		
3	5	395	36,50	5	009530130
3,5	6	395	36,50	3	009530135
4	6	395	36,50	5	009530140
4,5	7	395	36,50	3	009530145
5	7	395	36,50	5	009530150
6	9	400	39,50	5	009530160
7	10	425	43,50	3	009530170
8	11	425	43,50	5	009530180
10	13	440	52,00	5	009530200



<b>953/S5</b> 3-4-5-6-8 mm	<b>193,00</b>	1	009530305
<b>953/S9</b> 3-3,5-4-4,5-5-6-7-8-10 mm	<b>361,00</b>	1	009530301

## 953TX

chaves em T com macho de perfil Torx® articulado

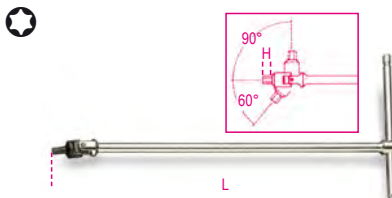

Ø mm	H mm	L mm	€		
T20	11	396	44,50	2	009530020
T25	11	396	44,50	2	009530025
T27	11	396	44,50	2	009530027
T30	13	400	49,00	2	009530030
T40	13	400	49,00	2	009530040
T45	13	426	50,50	2	009530045
T50	14	442	59,00	2	009530050
T55	14	442	59,50	2	009530055



<b>953TX/S8</b> T20-T25-T27-T30 T40-T45-T50-T55	<b>401,00</b>	1	009530060
---	---------------	---	-----------

# Beta **evox**

## A EVOLUÇÃO DA CHAVE DE FENDAS!

O desenho ergonómico adapta-se perfeitamente à palma da mão. A grande superfície de contacto permite transmitir a máxima força com esforço mínimo.

As hastes testadas da Beta garantem uma elasticidade, dureza e resistência ao desgaste únicas, para ferramentas profissionais topo de gama.

A secção octogonal impede que a chave role na bancada de trabalho.

A área de precisão permite que a chave de fendas seja rapidamente rodada entre os dedos.

O furo no cabo permite que a chave de fendas seja pendurada para fácil armazenamento. A nova borracha termoplástica torna cada utilização - mesmo em trabalhos pesados - ainda mais confortável.

A forma e o tamanho da ponta são impressos no cabo para uma identificação rápida.

As hastes testadas da Beta garantem uma elasticidade, dureza e resistência ao desgaste únicas, para ferramentas profissionais topo de gama.

**A secção octogonal** impede que a chave role na bancada de trabalho.

**O desenho ergonómico** adapta-se perfeitamente à palma da mão. A grande superfície de contacto permite transmitir a máxima força com esforço mínimo.

A área de precisão permite que a chave de fendas seja rapidamente rodada entre os dedos.

A nova borracha termoplástica torna cada utilização - mesmo em trabalhos pesados - ainda mais confortável.

A forma e o tamanho da ponta são impressos no cabo para uma identificação rápida.

O furo no cabo permite que a chave de fendas seja pendurada para fácil armazenamento.

### 1201E

chaves para parafusos de perfil de fenda



ISO 2380

SxAxL mm	L1 mm	Ø mm	€	🔧	📦
0,4x2,5x50	146	2,5	4,30	5	012011003
0,4x2,5x75	166	2,5	4,45	5	012011006
0,5x3x75	171	3,0	4,50	5	012011009
0,5x3x100	196	3,0	4,85	5	012011012
0,6x3,5x75	171	3,5	4,85	5	012011018
0,6x3,5x100	196	3,5	4,95	5	012011021
0,8x4x100	196	4,0	5,10	5	012011030
0,8x4x125	221	4,0	5,40	5	012011033
0,8x4x150	246	4,0	5,80	5	012011036
1,0x5,5x100	209	5,0	6,40	5	012011039
1,0x5,5x125	234	5,0	6,70	5	012011040
1,0x5,5x150	259	5,0	6,80	5	012011042
1,2x6,5x100	220	6,0	7,50	5	012011048
1,2x6,5x125	234	6,0	7,80	5	012011050
1,2x6,5x150	270	6,0	8,00	5	012011051
1,2x8x150	282	8,0	10,20	3	012011057
1,2x8x200	332	8,0	11,00	3	012011060
1,6x10x200	332	9,5	12,80	3	012011066



1201E/S6	€	🔧	📦
0,5x3x75-0,6x3,5x100 0,8x4x100-1,0x5,5x100 1,2x8x150-1,6x10x200 mm	43,50	1	012011206

### 1201EN

chave para parafusos de perfil de fenda, série extra curta



ISO 2380

SxAxL mm	L1 mm	Ø mm	€	🔧	📦
0,8x4x30	86,5	4	6,20	3	012011103
1,2x6,5x30	86,5	6	6,60	3	012011106

### 1201E/DZ

chave para parafusos de perfil Dzus®



L mm	L1 mm	€	🔧	📦
53	173	16,10	2	012011501

## 1202E

chave para parafusos de perfil Phillips®



UNI-HISO 8764

PHxDxL mm	L1 mm	€	🔧	📦
0x3x60	156	4,45	5	012021003
0x3x100	200	4,95	5	012021006
1x4,5x80	189	5,70	5	012021009
1x4,5x120	229	6,50	5	012021012
2x6x100	220	7,80	5	012021018
2x6x150	270	8,40	5	012021021
3x8x150	282	10,70	3	012021024
4x9,5x200	332	14,00	3	012021027



1202E/S4	€	🔧	📦
PH0x3x60-PH1x4,5x120 PH2x6x150-PH3x8x150 mm	30,00	1	012021204

## 1202EN

chave para parafusos de perfil Phillips®, série extra curta



UNI-HISO 8764

PHxDxL mm	L1 mm	€	🔧	📦
1x4,5x30	86,5	6,20	3	012021103
2x6x30	86,5	6,60	3	012021106

## 1202EL

chave para parafusos de perfil Phillips®, série longa



UNI-HISO 8764-1

PHxDxL mm	L1 mm	€	🔧	📦
0x3x300	400	8,00	3	012021303
1x4,5x300	400	8,70	3	012021305
1x4,5x400	508	10,60	3	012021306
2x6x400	519	12,20	3	012021309

## 1203E/D

conjunto de chaves de parafuso



1203E/D5	€	🔧	📦
1201E 0,6x3,5x100-1,0x5,5x150 1,2x6,5x150 mm	33,00	1	012031001

1203E/D5PZ	€	🔧	📦
1201E 0,5x3x75-0,8x4x125 1,0x5,5x150 mm	32,00	1	012031003

1209E/PZ	€	🔧	📦
PZ1x4,5x80-PZ2x6x100 mm			

1203E/D6	€	🔧	📦
1202E PH1x4,5x80-PH2x6x100 mm	34,00	1	012031006
1204E 0,4x2,5x60-0,5x3x100 0,8x4x100-1,0x5x125 mm			

1203E/D7	€	🔧	📦
1201E 0,5x3x75-0,8x4x100 1,0x5,5x100-1,2x6,5x150 mm	41,50	1	012031007
1202E PH0x3x60-PH1x4,5x80 PH2x6x100 mm			

1203E/D8	€	🔧	📦
1201E 0,5x3x75-0,8x4x125 1,0x5,5x150-1,2x6,5x150 mm	53,00	1	012031008
1202E PH0x3x60-PH1x4,5x80 PH2x6x100-PH3x8x150 mm			

1203E/D8P	€	🔧	📦
1201E 2,5x50-3x75-4x100 5,5x100-6,5x150 mm	46,00	1	012031018
1202E PH0x60-PH1x80-PH2x100 mm			

1203E/D10	€	🔧	📦
1201E 0,4x2,5x50-0,5x3x75 0,8x4x100-1,0x5,5x100 1,2x6,5x150-1,2x8x150 mm	67,00	1	012031010
1202E PH0x3x60-PH1x4,5x80 PH2x6x100-PH3x8x150 mm			

1203E/D10N	€	🔧	📦
1201E 0,4x2,5x50-0,5x3x75-0,8x4x100- 1,0x5,5x150-1,2x6,5x150 mm	58,50	1	012031019
1201EN 0,8x4x30 mm			
1202E PH0x3x60 - PH1x4,5x80 - PH2x6x100 mm			
1202EN PH1x4,5x30 mm			



## 1203E/S

Beta EVOLX



1203E/S8	€	🔧	📦
1201E 2,5x50-3x75-4x100 5,5x125-6,5x150 mm	46,00	1	012031009
1202E PH0x3x60-PH1x4,5x80 PH2x6x100 mm			

1203E/S10	€	🔧	📦
1201E 0,4x2,5x50-0,5x3x75 0,8x4x125-1,0x5,5x150 1,2x6,5x150-1,2x8x150 mm	67,50	1	012031021
1202E PH0x3x60-PH1x4,5x80 PH2x6x100-PH3x8x150 mm			

## 1204E

chave para parafusos de perfil de fenda sem cabeça



ISO 2380

SxDxL mm	L1 mm	€	🔧	📦
0,4x2,5x60	156	4,40	5	012041003
0,6x3x75	175	4,50	5	012041006
0,5x3x100	196	4,60	5	012041009
0,8x4x100	196	5,20	5	012041012
0,8x4x125	233	5,50	5	012041015
1x5x125	234	6,40	5	012041018
1x5x150	258	6,90	5	012041021
1,2x6,5x150	270	7,50	5	012041024



1204E/S5	€	🔧	📦
0,4x2,5x60-0,5x3x100 0,8x4x100-1x5x125 1,2x6,5x150 mm	28,00	1	012041205

## 1204EL

chave para parafusos de perfil de fenda sem cabeça, série longa



ISO 2380

SxDxL mm	L1 mm	€	🛒	📦
0,5x2,5x200	300	6,60	3	012041303
0,5x3x300	400	7,80	3	012041306
0,8x4x400	508	9,60	3	012041309
1x5x400	508	10,20	3	012041315
1,2x6,5x400	519	13,10	3	012041318

## 1205E/ES

chaves sextavadas com punho



mm	L mm	L1 mm	€	🛒	📦
1,5	100	200	5,60	3	012051315
2	100	200	5,70	3	012051320
2,5	100	200	5,80	3	012051325
3	100	200	6,00	3	012051330
4	100	208	6,90	3	012051340
5	100	219	8,20	3	012051350
6	125	244	8,40	3	012051360
8	150	277	11,20	2	012051380



1205E/ES-S8 € 57,50 1 012051408  
1,5-2-2,5-3-4-5-6-8 mm

## 1206E/BP

chaves sextavadas macho com extremidade esférica e punho



mm	L mm	L1 mm	Ø mm	€	🛒	📦
2	100	198	2,5	6,30	3	012061320
2,5	100	198	3,0	6,40	3	012061325
3	100	198	3,5	6,50	3	012061330
4	100	209	5,0	7,20	3	012061340
5	100	220	6,0	8,70	3	012061350
6	125	245	7,0	8,90	3	012061360
8	150	287	9,5	11,90	2	012061380



1206E/BP-S7 € 55,50 1 012061407  
2-2,5-3-4-5-6-8 mm

## 1207E/TX

chaves para parafusos de perfil Torx®, com punho



	L mm	L1 mm	Ø mm	€	🛒	📦
T5	50	150	3	6,70	5	012071005
T6	60	156	4	7,10	5	012071006
T7	60	156	4	7,20	5	012071007
T8	60	156	4	7,30	5	012071008
T9	60	156	4	7,70	5	012071009
T10	80	189	5	8,70	5	012071010
T15	80	189	5	8,80	5	012071015
T20	100	209	5	8,90	5	012071020
T25	100	209	5	9,20	5	012071025
T27	100	220	6	9,80	5	012071027
T30	100	220	6	9,90	5	012071030
T40	130	262	7	11,70	2	012071040
T45	130	262	8	12,90	2	012071045



1207E/TX-D7 € 59,50 1 012071207  
T6-T8-T10-T15

1207E/TX-S13 € 116,00 1 012071213  
T5-T6-T7-T8-T9-T10-T15  
T20-T25-T27-T30-T40-T45

## 1208E/RTX

chaves para parafusos de perfil Tamper Resistant Torx®, com punho



⊕	L mm	L1 mm	Ø mm	€	🛒	📦
T9	60	156	4	7,80	5	012081009
T10	80	189	5	8,70	5	012081010
T15	80	189	5	9,20	5	012081015
T20	100	209	5	9,40	5	012081020
T25	100	209	5	9,60	5	012081025
T27	100	220	6	10,40	5	012081027
T30	100	220	6	10,90	5	012081030
T40	130	262	7	13,00	2	012081040



1208E/RTX-D7 € 66,00 1 012081207  
T9-T10-T15-T20  
T25-T27-T30

## 1209E/PZ

chave para parafusos de perfil Pozidriv®-Supadriv®



UNI-ISO 8764

PZ	L mm	L1 mm	€	🛒	📦
0	60	156	5,20	5	012091000
1	80	189	6,80	5	012091003
2	100	220	8,70	5	012091006
3	150	282	13,30	3	012091009
4	200	327	14,50	3	012091012



1209E/PZ-S4 € 33,50 1 012091204  
PZ0-PZ1-PZ2-PZ3

## 1209EN/PZ

chave para parafusos de perfil Pozidriv®-Supadriv®, série extra curta



ISO 8764

PZ	L mm	L1 mm	€	🛒	📦
1	30	87	6,20	3	012091103
2	30	87	6,60	3	012091106

## CHAVE DE FENDAS ELÉTRICA BETA EVOX-E

A chave de fendas elétrica Beta Evox-E é ideal para realizar trabalhos de alta precisão com o mínimo esforço e máxima rapidez.



### CONFORTÁVEL

Dimensões reduzidas para utilização em espaços pequenos e LEDs frontais para excelente visibilidade do ponto de trabalho.

### DESIGN ERGONÓMICO

O punho adapta-se perfeitamente à palma da mão, para um trabalho firme e confortável.

1/4



USB-C

#### Vida útil da bateria

Bateria de lítio de longa duração de 3,7V 2300mAh, permitindo apertar até 1.000 parafusos com um ciclo de carga.

Está disponível em duas variantes:

- chave de fendas elétrica 1210E/GE com pontas



- chave de fendas elétrica 1211E/GE com pontas isoladas de 1000V



⚡ 1000 V



### 1210E/GE

chave de fendas Evox-E elétrica

- 4-5 mm
- ⊕ PH2
- ⊕ PZ2
- ⊛ T25 - T30



L mm 150 € 183,00 1 0121100701

### 1211E/GE

chave de fendas Evox-E elétrica

- 3,5x0,6 - 5,5x1 mm
- ⊕ PH2/SL
- ⊕ PH2
- ⊕ PZ2/SL
- ⊕ PZ2



L mm 150 € 194,00 1 012110701

### 1229LP/S



1229LP/A6 € 28,00 1 012290300  
1,2-1,4-1,8-2-2,4-3 mm

### 1229LPH/A6

jogo de 6 chaves de relojoeiro 1229LP-1229PH



● ⊕ 1229LPH/A6 € 28,00 1 012290310  
1229LP 1,4-2,0-2,4-3 mm  
1229PH PH0-PH1

## 1236B

chave de parafusos angular para parafusos de perfil de fenda



UNI 7079 DIN 5200

SxA	L	€		
mm	mm			
0,8x4	100	8,00	5	012360201
1x5,5	125	9,30	5	012360202
1,2x8	150	11,50	5	012360204

## 1238B

chave de parafusos angular para parafusos de perfil Phillips®



UNI 7083 DIN 5208

PH	L	€		
	mm			
1-2	125	9,50	5	012380201
3-4	200	15,40	5	012380203

## 1241

chave de parafusos com ponta de aço para parafusos de perfil de fenda

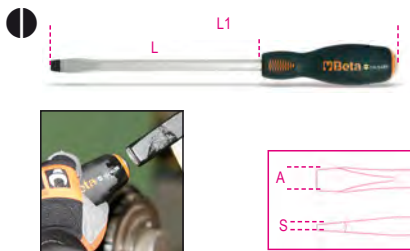

ISO 2380

SxAxL	L1	€		
mm	mm			
1x5,5x100	202	12,50	5	012410039
1,2x6,5x125	240	13,80	5	012410050
1,2x8x150	268	16,80	3	012410057
1,6x10x175	300	21,00	2	012410065
1,6x10x200	325	21,50	2	012410066
2,0x12x200	325	22,60	2	012410067
2,5x14x250	375	24,80	2	012410076

## 1242

chave de parafusos com ponta de aço para parafusos com perfil Phillips®



UNI/ISO 8764

PHxDxL	L1	€		
mm	mm			
1x4,5x100	202	12,30	5	012420209
2x6x100	215	14,50	5	012420218
3x8x150	268	18,60	3	012420221
4x11x200	325	24,10	2	012420224

## 1243LP/D6

jogo 6 chaves de fendas com cabeça em aço, para parafusos de cabeça ranhurada



	€		
1243LP/D6	112,00	1	012430016
1241			

## 1243/D7

Jogo de 7 chaves de parafusos com ponta de aço



	€		
1243/D7	110,00	1	012430017
1241			

## 1243/S11

jogo 11 chaves de fendas com cabeça em aço



	€		
1243/S11	202,00	1	012430021
1241			

## 1250

chaves de fenda com guia prensili

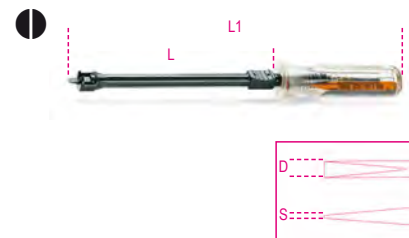

SxDxL	L1	€		
mm	mm			
0,5x3x125	190	17,70	5	012500030
0,6x4x125	225	19,10	5	012500040
0,7x5x150	255	22,50	5	012500050

## 1251

chaves para parafusos de perfil Phillips® com guia prensili

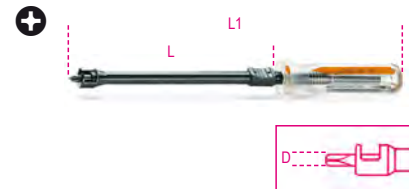

PHxDxL	L1	€		
mm	mm			
0x4x125	225	19,90	5	012510000
1x5x125	225	23,00	5	012510010
2x6x175	280	26,50	5	012510020

## 1252/S5



	€		
1252/S5	109,00	1	012520001
1250			



## 1253

busca-pólos 150/250V

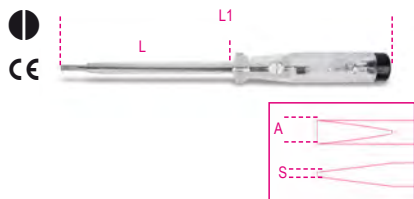

SxAxL mm	L1 mm	€	5	012530001
0,5x3,5x100	190	11,30		

## 1253A

busca-pólos 125/250V,  
duplo isolamento



SxAxL mm	L1 mm	€	5	012530010
0,5x3x15	150	8,00		

## 1254

busca-pólos 6/24V

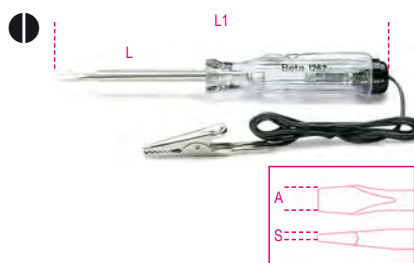

SxAxL mm	L1 mm	€	5	012540001
0,5x3x44	123	12,40		

## 1256/C36-2

punho para micro-chaves com 36 pontas  
intermutáveis de 4 mm e extensão magnética



1256/C36-2	€	5	012560100
	75,00		

	1256TX	T3 - T4 - T5 - T6 - T7 T8 - T9 - T10 - T15
	1256RTX	T6 - T7 - T8 - T9 - T10
	1256LP	0,8 - 1,2 - 1,5 - 1,8 - 2 - 2,5 3 - 3,5 - 4 mm
	1256PE	0,7 - 0,9 - 1,3 - 1,5 - 2 mm
	1256PH	PH000 - PH00 - PH0 - PH1
	1256PZ	PZ000 - PZ00 - PZ0 - PZ1
	1256/20	
	1256/30	
130x60x35 mm - 200 g		



## 1256LP

bits 4 mm  
para parafusos ranhurados

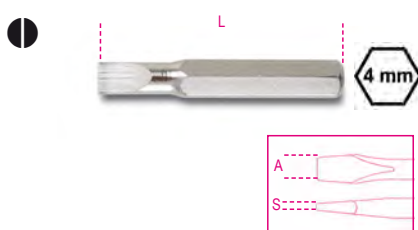

SxA	L	€	5	012560001
0,25x0,8	27	1,46		
0,25x1,2	27	1,46		
0,3x1,5	27	1,46		
0,35x1,8	27	1,46		
0,4x2,0	27	1,46		
0,4x2,5	27	1,46		
0,5x3,0	27	1,46		
0,6x3,5	27	1,46		
0,8x4,0	27	1,46		

## 1256PH

bits 4 mm  
para parafusos Phillips®



PH	L	€	5	012560011
000	27	1,46		
00	27	1,46		
0	27	1,46		
1	27	1,46		

## 1256PZ

bits 4 mm  
para parafusos de cabeça ranhurada Pozidriv®  
- Supradriv®



PZ	L	€	5	012560061
000	27	1,46		
00	27	1,46		
0	27	1,46		
1	27	1,46		

## 1256PE

bits 4 mm  
para parafusos sextavados



mm	L	€	5	012560021
0,7	27	1,46		
0,9	27	1,46		
1,3	27	1,46		
1,5	27	1,46		
2,0	27	1,46		

## 1256TX

bits 4 mm  
para parafusos Torx®



T	L	€	5	012560041
T3	27	1,52		
T4	27	1,52		
T5	27	1,52		
T6	27	1,52		
T7	27	1,52		
T8	27	1,52		
T9	27	1,52		
T10	27	1,52		
T15	27	1,52		

## 1256RTX

bits 4 mm  
para parafusos invioláveis "Tamper Resistant  
Torx®"



T	L	€	5	012560051
T6	27	1,82		
T7	27	1,82		
T8	27	1,82		
T9	27	1,82		
T10	27	1,82		

## 1256/20

extensão sextavada, 4 mm



1256/20	€	5	012560092
	9,20		

## 1256/30

porta-bits 4 mm com punho



L	€	5	012560097
110	10,90		

## 1257LP

micro-chaves para parafusos de perfil de fenda



SxD mm	L mm	€	🔧	📦
0,25x1,2	60	5,80	5	012570012
0,23x1,5	60	5,80	5	012570015
0,3x1,8	60	5,80	5	012570018
0,4x2	60	5,80	5	012570020
0,4x2,5	60	5,80	5	012570024
0,5x3	60	5,80	5	012570030
0,6x3,5	60	5,80	5	012570035
0,8x4	60	5,80	5	012570040



1257LP/S8	€	🔧	📦
0,2x1,2-0,25x1,5 0,3x1,8-0,4x2-0,4x2,5 0,5x3-0,6x3,5-0,8x4 mm	73,00	1	012570200

## 1257PH

micro-chaves para parafusos de perfil Philips®



PH	L mm	€	🔧	📦
00	60	5,80	5	012570060
0	60	5,80	5	012570063
1	60	5,80	5	012570066



## 1257LPH/S8

Jogo de 8 micro-chaves (refa. 1257LP, 1257PH) em caixa



1257LPH/S8	€	🔧	📦
1257PH PH00-PH0-PH1 1257LP 0,4x2-0,4x2,5-0,5x3 0,6x3,5-0,8x4 mm	73,00	1	012570210

## 1257ES

micro-chaves com ponta macho hexagonal



mm	L mm	€	🔧	📦
0,9	60	6,60	5	012570045
1,3	60	6,60	5	012570046
1,5	60	6,60	5	012570047
2	60	6,60	5	012570048
2,5	60	6,60	5	012570049
3	60	6,60	5	012570050

## 1257ESB/S8



1257ESB/S8	€	🔧	📦
1257ES 0,9-1,3-1,5-2-2,5-3 mm 1257BE 4-5 mm	83,00	1	012570230

## 1257TX

micro-chaves para parafusos de perfil Torx®



mm	L mm	€	🔧	📦
T5	60	6,90	5	012570075
T6	60	6,90	5	012570076
T7	60	6,90	5	012570077
T8	60	6,90	5	012570078
T9	60	6,90	5	012570079
T10	60	6,90	5	012570080
T15	60	6,90	5	012570081
T20	60	6,90	5	012570082



1257TX/S8	€	🔧	📦
T5-T6-T7-T8 T9-T10-T15-T20	81,50	1	012570220

## 1257BE

micro-chave de fenda para parafusos macho sextavados



mm	L mm	€	🔧	📦
3,2	60	8,60	5	012570085
4	60	8,60	5	012570086
5	60	8,60	5	012570087
5,5	60	8,60	5	012570088





As chaves BetaGrip são fruto da longa experiência da Beta no design de chaves de fendas e da estreita colaboração com mecânicos de equipas de automobilismo.

Novas e exclusivas soluções técnicas, capazes de satisfazer os requisitos dos profissionais mais exigentes, foram utilizadas com o objetivo de alcançar os mais altos padrões de ergonomia, robustez e qualidade dos materiais.

- A haste é fabricada em aço especial com elevado teor de silicone, cromo e vanádio, para garantir uma excelente performance em termos de força de torção e flexibilidade. O acabamento escolhido foi um revestimento cromado mate.
- A geometria da ponta foi concebida para assegurar um encaixe perfeito entre a haste e a cabeça do parafuso. O acabamento com revestimento de fosfato previne a oxidação da ponta, mantendo simultaneamente perfis perfeitos.
- A textura foi buscar inspiração aos rastros dos pneus de Corrida, desenvolvidos para maximizar a aderência em diferentes pavimentos. Garante assim uma retenção eficiente da chave de fendas em quaisquer condições de trabalho, para maior precisão e controlo ao encaixar a ponta no parafuso.



## 1260

chaves para parafusos de perfil de fenda



ISO 2380

SxAxL mm	L1 mm	Ø mm	€	🔧	📦
0,4x2,5x50	150	2,5	6,00	5	012600003
0,4x2,5x75	175	2,5	6,30	5	012600006
0,5x3x75	175	3,0	6,40	5	012600009
0,5x3x100	200	3,0	6,60	5	012600012
0,6x3,5x75	175	3,5	6,80	5	012600018
0,6x3,5x100	200	3,5	6,90	5	012600021
0,8x4x100	208	4,0	7,50	5	012600030
0,8x4x125	233	4,0	7,90	5	012600033
0,8x4x150	258	4,0	8,20	5	012600036
1x5,5x100	208	5,0	8,60	5	012600039
1x5,5x125	233	5,0	8,80	5	012600040
1x5,5x150	258	5,0	9,60	5	012600042
1,2x6,5x100	219	6,0	10,40	5	012600048
1,2x6,5x125	244	6,0	10,80	5	012600050
1,2x6,5x150	269	6,0	11,20	5	012600051
1,2x8x150	277	8,0	13,70	3	012600057
1,2x8x200	327	8,0	14,10	3	012600060
1,6x10x200	327	9,5	17,10	3	012600066
2x12x250	377	10	20,30	3	012600069
2x14x250	377	10	21,50	2	012600073



1260/S6	€	🔧	📦
0,4x2,5x75-0,5x3x75-0,8x4x125 1x5,5x150-1,2x6,5x150-1,2x8x200 mm	55,50	1	012600306

## 1260N

chaves para parafusos de perfil de fenda, série extra curta



ISO 2380

SxAxL mm	L1 mm	Ø mm	€	🔧	📦
0,8x4x30	87	4	8,00	5	012600103
1,2x6,5x30	87	6	8,80	5	012600106



## 1260E

chaves para parafusos de perfil de fenda com sextavado auxiliar



ISO 2380

SxAxL mm	L1 mm	Ø mm	€		
1,2x6,5x150	269	6,0	14,50	3	012600156
1,2x8x175	301	8,0	17,80	3	012600157
1,6x10x200	327	9,5	20,60	2	012600159
2x12x250	377	9,5	23,90	2	012600162

## 1260MC

chaves para parafusos de perfil de fenda, coloridas



SxAxL mm	L1 mm	Ø mm	€		
0,4x2,5x50	150	2,5	6,50	3	012602003
0,6x3,5x75	175	3,5	6,70	3	012602018
0,8x4x100	208	4,0	8,00	3	012602030
1x5,5x150	233	5,0	10,20	5	012602040
1,2x6,5x150	269	6,0	11,70	5	012602051

## 1262

chaves para parafusos de perfil Phillips(R)



UNI/ISO 8764

PHxDxL mm	L1 mm	€		
0x3x60	160	6,40	5	012620003
0x3x100	200	6,80	5	012620006
1x4,5x80	188	8,40	5	012620009
1x4,5x120	228	9,10	5	012620012
2x6x100	219	10,30	5	012620018
2x6x150	269	11,30	5	012620021
3x8x150	277	15,20	3	012620024
4x10x200	327	19,30	3	012620027



1262/S4	€		
PH0x3x60-PH1x4,5x80 PH2x6x100-PH3x8x150 mm	40,00	1	012620304

## 1262N

chaves para parafusos de perfil Phillips®, série extra curta



UNI/ISO 8764

PHxDxL mm	L1 mm	€		
1x4,5x30	87	8,00	5	012620103
2x6x30	87	8,80	5	012620106

## 1262E

chaves para parafusos de perfil Phillips® com sextavado auxiliar



UNI/ISO 8764

PHxDxL mm	L1 mm	€		
2x6x150	269	14,50	3	012620153
3x8x175	302	17,60	3	012620156
4x10x200	327	22,20	2	012620159

## 1262L

chaves para parafusos de perfil Phillips®, série longa



UNI/ISO 8764-1

PHxDxL mm	L1 mm	€		
0x3x300	400	11,00	3	012620203
1x4,5x300	400	13,20	3	012620205
1x4,5x400	508	15,30	3	012620206
2x6x400	519	19,90	3	012620209

## 1262MC

chaves para parafusos de perfil Phillips®, coloridas



PHxDxL mm	L1 mm	€		
0x3x60	160	6,70	3	012622003
1x4,5x80	188	8,70	3	012622009
2x6x100	219	10,80	3	012622018

## 1263/D...

jogo de chaves de parafusos



1263/D6	€		
1260 1262	52,50	1	012630006

0,5x3x75-0,8x4x100  
1x5,5x125-1,2x6,5x150 mm  
PH1x4,5x80-PH2x6x100 mm

1263/D7	€		
1262	54,00	1	012630017

PH0x3x60  
PH1x4,5x80  
PH2x6x100 mm  
0,5x2,5x60-0,6x3x100  
0,8x4x125-1x5x125 mm

1263/D7PZ	€		
1260	63,00	1	012630007

0,5x3x75-0,8x4x100  
1x5,5x150-1,2x6,5x150 mm  
PZ0 - PZ1 - PZ2

1263/D8	€		
1260	65,00	1	012630008

0,4x2,5x50-0,5x3x75  
0,8x4x100-1x5,5x125  
1,2x6,5x150 mm  
PH0x3x60-PH1x4,5x80  
PH2x6x100 mm

1263/D10	€		
1260	83,00	1	012630010

0,5x3x75-0,6x3,5x100  
0,8x4x125-1x5,5x150  
1,2x6,5x150 mm  
1260N  
1262  
1262N

## 1263/S12

jogo de 12 chaves de parafusos



1263/S12 € 118,00 1 012630112

1260	0,4x2,5x50-0,5x3x75 0,6x3,5x100-0,8x4x125 1x5,5x125-1,2x6,5x150 1,2x8x200-1,6x10x200 mm
1262	PH0x3x60-PH1x4,5x80 PH2x6x100-PH3x8x150 mm

## 1263MC/D8

jogo de 8 chaves de parafusos coloridas



1263MC/D8 € 69,00 1 012632008

1260MC	0,4x2,5x50-0,5x3x75 0,8x4x100-1x5,5x125 1,2x6,5x150 mm
1262MC	PH0x3x60-PH1x4,5x80 PH2x6x100 mm

## 1264

jogo de chaves para parafusos de perfil de fenda sem cabeça



SxAxL mm	L1 mm	€	U	U
0,5x2,5x60	160	6,00	5	012640003
0,6x3x75	175	6,40	5	012640006
0,6x3x100	200	6,60	5	012640009
0,8x4x100	208	7,50	5	012640012
0,8x4x125	233	7,90	5	012640015
1x5x125	233	8,80	5	012640018
1x5x150	258	9,30	5	012640021
1,2x6,5x150	269	11,20	5	012640024



1264/S5 € 40,00 1 012640305  
0,5x2,5x60-0,6x3x75  
0,8x4x100-1x5x125-1,2x6,5x150 mm

## 1264L

jogo de chaves para parafusos de perfil de fenda sem cabeça, série longa

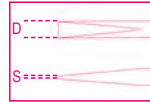

SxAxL mm	L1 mm	€	U	U
0,5x2,5x200	300	8,90	3	012640203
0,6x3x300	400	10,50	3	012640206
0,8x4x400	508	13,70	3	012640209
1x5x400	508	15,30	3	012640215
1,2x6,5x400	519	18,60	3	012640218

## 1265ES

chaves hexagonais com punhos



mm	L mm	L1 mm	€	U	U
1,5	100	200	7,30	3	012650015
2	100	200	7,50	3	012650020
2,5	100	200	7,80	3	012650025
3	100	200	8,20	3	012650030
4	100	208	9,00	3	012650040
5	100	219	10,40	3	012650050
6	125	244	11,70	3	012650060
8	150	277	15,60	2	012650080



1265ES/S8 € 77,50 1 012650308  
1,5-2-2,5-3-4-5-6-8 mm

## 1266BP

chaves hexagonais de extremidade esférica com punhos

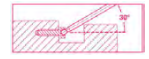

mm	L mm	L1 mm	€	U	U
2	100	200	8,00	3	012660020
2,5	100	200	8,30	3	012660025
3	125	225	8,60	3	012660030
4	125	233	9,60	3	012660040
5	120	239	11,20	3	012660050
6	140	259	13,00	3	012660060
8	160	287	16,30	2	012660080
10	160	287	19,60	2	012660100



1266BP/S8 € 94,50 1 012660308  
2-2,5-3-4-5-6-8-10 mm

## 1267TX

chaves para parafusos de perfil Torx®, com punhos



mm	L mm	L1 mm	Ø mm	€	U	U
T5	50	150	3	8,90	5	012670005
T6	50	150	3	9,30	5	012670006
T7	50	150	3	9,60	5	012670007
T8	60	160	3	10,10	5	012670008
T9	60	167	4	10,50	5	012670009
T10	80	188	4	10,90	5	012670010
T15	80	188	4	11,50	5	012670015
T20	100	208	4,5	12,20	5	012670020
T25	100	208	5	13,20	5	012670025
T27	115	234	6	13,70	5	012670027
T30	115	234	6	14,40	5	012670030
T40	130	257	7	16,70	2	012670040
T45	130	257	8	18,40	2	012670045





**1267TX/D7**  
T6-T8-T10-T15  
T20-T25-T30

€ 81,50 1 012670307



**1267TX/S13**  
T5-T6-T7-T8-T9  
T10-T15-T20-T25  
T27-T30-T40-T45

€ 159,00 1 012670312

### 1267MC/TX

chaves para parafusos de perfil Torx®, com punhos, coloridas



Ø	L mm	L1 mm	Ø mm	€	1	012672006
T6	50	150	3	9,80	5	012672006
T8	60	160	3	10,40	5	012672008
T10	80	188	4	11,40	5	012672010
T15	80	188	4	12,20	5	012672015
T20	100	208	4,5	13,00	5	012672020
T25	100	208	5	13,60	3	012672025
T30	115	234	6	14,90	3	012672030



**1267MC/TX-D7**  
T6-T8-T10-T15  
T20-T25-T30

€ 85,00 1 012672307

### 1268RTX

chaves para parafusos de perfil Tamper Resistant Torx®, com punhos



Ø	L mm	L1 mm	Ø mm	€	1	012680009
T9	60	167	4,0	11,40	3	012680009
T10	80	188	4,0	11,80	3	012680010
T15	80	188	4,0	12,20	3	012680015
T20	100	208	4,5	13,20	3	012680020
T25	100	208	5,0	13,50	3	012680025
T27	115	234	6,0	14,40	3	012680027
T30	115	234	6,0	14,60	3	012680030
T40	130	257	7,0	16,90	2	012680040



**1268RTX/S8**  
T9-T10-T15-T20  
T25-T27-T30-T40

€ 108,00 1 012680307

### 1269PZ

chaves para parafusos de perfil Pozidriv®-Supadriv®



UNI/ISO 8764

PZ	L mm	L1 mm	€	1	012690000
0	60	160	7,30	5	012690000
1	80	188	9,50	5	012690001
2	100	219	11,40	5	012690002
3	150	277	16,30	3	012690003
4	200	327	20,80	3	012690004



**1269PZ/S4**  
PZ0-PZ1-PZ2-PZ3

€ 44,50 1 012690304

### 1269N/PZ

chaves para parafusos de perfil Pozidriv®-Supadriv®, série extra curta



UNI/ISO 8764

PZ	L mm	L1 mm	€	1	012690011
1	30	87	8,00	5	012690011
2	30	87	8,80	5	012690012

### 1281BG

punho para chave de parafusos de lâmina intermutável



L mm	Ø mm	€	1	012810280
118	10	13,40	5	012810280

### 1281PM

porta-pontas magnético de fixação rápida



L mm	€	1	012810292
165	22,80	5	012810292

### 1281PB

porta-chaves de caixa com quadra macho 1/4"



L mm	€	1	012810293
175	18,30	5	012810293

### 1281LP

lâmina reversível intermutável para parafusos de perfil de fenda



1281LP/1	€	1	012810302
0,8x4-1,2x6,5 mm	11,70	5	012810302
1281LP/2	€	1 <td>012810304</td>	012810304
1x5,5-1,2x6,5 mm	11,70	5	012810304

## 1281PH

lâmina reversível intermutável  
para parafusos de perfil Phillips®



PH	€	5	012810310
1-2	11,70		
2-3	11,70		012810312

## 1281LPH

lâmina reversível intermutável  
para parafusos de perfil Phillips® e fenda



	€	5	012810321
1281LPH/1 PH0-0,8x4 mm	11,70		
1281LPH/2 PH1-1x5,5 mm	11,70		012810322
1281LPH/3 PH2-1,2x6,5 mm	11,70		012810323

## 1281PZ

lâmina reversível intermutável  
para parafusos de perfil Pozidriv®-Supadriv®



PZ	€	5	012810330
1-2	11,70		
2-3	11,70		012810332

## 1281PE

lâmina reversível intermutável  
hexagonal macho, esférica



mm	€	5	012810342
2,5	11,50		
3	11,50		012810343
4	11,50		012810344
5	11,50		012810345
6	11,50		012810346

## 1281TX

lâmina reversível intermutável  
para parafusos de perfil Torx®

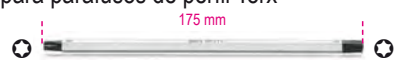

	€	5	012810349
1281TX/1 T6-T8	12,90		
1281TX/2 T7-T9	12,90		012810350
1281TX/3 T10-T15	12,90		012810351
1281TX/4 T20-T25	12,90		012810352
1281TX/5 T30-T40	12,90		012810353

## 1281RTX

lâmina reversível intermutável  
para parafusos de perfil Tamper Resistant  
Torx®



	€	5	012810361
1281RTX/3 T10-T15	13,10		
1281RTX/4 T20-T25	13,10		012810362
1281RTX/5 T30-T40	13,10		012810363

## 1281BG/A9

jogo 9 chaves reversíveis  
e 1 acessório em bolsa



1281BG/A9	€	1	012810520
	137,00		

1281BG	
1281LPH/1	PH0-0,8x4 mm
1281LPH/2	PH1-1x5,5 mm
1281LPH/3	PH2-1,2x6,5 mm
1281PZ/1	PZ1-PZ2
1281PE	2,5 mm
1281PE	3 mm
1281PE	4 mm
1281PE	5 mm
1281PE	6 mm

## 1281BG-TX/A8

jogo 8 chaves reversíveis  
e 1 acessório em bolsa



1281BG-TX/A8	€	1	012810530
	131,00		

1281BG	
1281LPH/1	PH0-0,8x4 mm
1281LPH/2	PH1-1x5,5 mm
1281LPH/3	PH2-1,2x6,5 mm
1281TX/1	T6-T8
1281TX/2	T7-T9
1281TX/3	T10-T15
1281TX/4	T20-T25
1281TX/5	T30-T40

## 1281BG/B28NA

sortido de 16 chaves para parafusos  
reversíveis, 9 chaves de caixa 1/4", 2  
acessórios e 1 punho, em bolsa de poliéster



1281BG/B28NA	€	1	012810511
	301,00		

900	
1281BG	4 - 4,5 - 5 - 5,5 6 - 7 - 8 - 9 - 10 mm
1281PB	1/4"
900/25	
1281LP/1	0,8x4 - 1,2x6,5 mm
1281LP/2	1,0x5,5 - 1,2x6,5 mm
1281PH/1	PH1 - PH2
1281PH/2	PH2 - PH3
1281PZ/1	PZ1 - PZ2
1281PZ/2	PZ2 - PZ3
1281PE	2,5 - 3 - 4 - 5 - 6 mm
1281TX/1	T6 - T8
1281TX/2	T7 - T9
1281RTX/3	T10 - T15
1281RTX/4	T20 - T25
1281RTX/5	T30 - T40

2002/BV7-ZIP	€	1	020020060
	22,70		



### As chaves de fendas BetaMax

possuem várias características técnicas que proporcionam ainda maior facilidade de trabalho.

- O punho, inspirado na secção triangular, assegura um trabalho excelente, com um alcance de 120°, em linha com a rotação máxima do pulso.
- O design confere extraordinárias propriedades em termos de ergonomia durante as operações de aparafusar com rapidez e de apertar.
- A ponta sem cromado e com revestimento de fosfato anti-oxidação, garante o encaixe perfeito com o parafuso.



### 1290

chaves para parafusos de perfil de fenda



ISO 2380

SxAxL mm	L1 mm	Ø mm	€		
0,4x2,5x50	146	2,5	7,70	5	012900003
0,4x2,5x75	171	2,5	8,00	5	012900006
0,5x3x75	171	3,0	8,10	10	012900009
0,5x3x100	196	3,0	8,50	10	012900012
0,6x3,5x75	171	3,5	9,20	10	012900018
0,6x3,5x100	196	3,5	9,40	10	012900021
0,8x4x100	196	4,0	9,50	10	012900030
0,8x4x125	221	4,0	9,70	10	012900033
0,8x4x150	246	4,0	10,40	10	012900036
1x5,5x100	209	5,0	10,60	10	012900039
1x5,5x150	259	5,0	11,70	10	012900042
1,2x6,5x100	220	6,0	13,20	10	012900048
1,2x6,5x150	270	6,0	13,90	10	012900051
1,2x8x150	282	7,0	17,40	3	012900057
1,2x8x200	332	7,0	18,50	3	012900060
1,6x10x200	332	8,0	21,70	3	012900066
2x12x250	382	10	29,00	2	012900069

### 1290/S

jogo de chaves de parafusos



	€		
<b>1290/S5</b>	<b>61,00</b>	1	012900305
1290	0,5x3x75-0,8x4x100 -1x5,5x150 1,2x6,5x150 -1,2x8x150 mm		
<b>1290/S9X</b>	<b>114,00</b>	1	012900319
1290	0,4x2,5x75 - 0,5x3,5x100 0,8x4x125 - 1x5,5x150 1,2x6,5x150 - 1,2x8x200 1,6x10x200 mm		
1290N	0,8x4x30 -1,2x6,5x30 mm		

### 1290N

chaves série curta para parafusos de perfil de fenda



ISO 2380

SxAxL mm	L1 mm	Ø mm	€		
0,8x4x30	86	4	10,00	5	012900103
1,2x6,5x30	86	6	11,10	5	012900106

### 1292

chaves para parafusos de perfil Phillips®



UNI/ISO 8764

PHxDxL mm	L1 mm	€		
0x3x60	156	7,30	10	012920003
0x3x100	196	8,40	5	012920006
1x4,5x80	189	10,10	10	012920009
1x4,5x120	229	11,20	10	012920012
2x6x100	220	13,40	10	012920018
2x6x150	270	14,30	10	012920021
3x8x150	282	18,30	3	012920024
4x10x200	332	25,00	3	012920027



	€		
<b>1292/S4</b>	<b>48,50</b>	1	012920304
PH0x3x60-PH1x4,5x80 PH2x6x100-PH3x8x150 mm			

### 1292N

chaves série curta para parafusos de perfil Phillips®



UNI/ISO 8764

PHxDxL mm	L1 mm	€		
1x4,5x30	86	9,60	5	012920103
2x6x30	86	10,50	5	012920106

### 1292L

chaves série longa para parafusos de perfil Phillips®



UNI/ISO 8764-1

PHxDxL mm	L1 mm	€		
0x3x300	396	16,30	3	012920203
1x4,5x400	509	20,10	3	012920206
2x6x400	520	24,70	3	012920209

## 1293/D...

jogo de chaves de parafusos

**Betamax**  
MAXIMUM PERFORMANCE



1293/D6 € 65,50 1 012930401

1290 0,6x3,5x75-1x5,5x150  
1,2x6,5x150 mm  
1292 PH0x3x60 -PH1x4,5x80  
PH2x6x100 mm

1293/D8 € 91,50 1 012930403

1290 0,5x3x75-0,8x4x100  
1x5,5x150-1,2x6,5x150  
1,2x8x150 mm  
1292 PH0x3x60 -PH1x4,5x80  
PH2x6x100 mm

## 1293/S...

jogo de chaves de parafusos

**Betamax**  
MAXIMUM PERFORMANCE



1293/S8 € 81,50 1 012930208

1290 2,5x50-3x75-4x100-5,5x150  
6,5x150 mm  
1292 PH0x3x60 -PH1x4,5x80  
PH2x6x100 mm

1293/S10 € 130,00 1 012930201

1290 0,4x2,5x50 -0,6x3,5x100  
1x5,5x100-1,2x6,5x150  
1,2x8x150-1,6x10x200 mm  
1292 PH0x3x60 -PH1x4,5x80  
PH2x6x100-PH3x8x150 mm

1293/S12 € 141,00 1 012930203

1290 0,5x3x75-0,8x4x125  
1x5,5x150-1,2x6,5x150  
1,2x8x200 mm  
1290N 0,8x4x30 mm  
1292 PH0x3x60 -PH1x4,5x80  
PH2x6x100-PH3x8x150 mm  
1292N PH1x4,5x30-PH2x6x30 mm

1293/S7 € 67,00 1 012930207

1292 PH0x3x60 -PH1x4,5x80  
PH2x6x100 mm  
1294 0,5x2,5x60-0,6x3x75  
0,8x4x100-1x5x125 mm

## 1293ES

chaves hexagonal macho com punho

**Betamax**  
MAXIMUM PERFORMANCE



mm	L mm	L1 mm	Ø mm	€	U	U
2	100	196	3	10,40	5	012930001
2,5	100	196	4	10,40	5	012930002
3	100	196	4	10,70	5	012930003
4	100	196	5	12,00	5	012930004
5	100	209	6	13,40	5	012930005
6	125	245	7	15,20	5	012930006
8	150	282	10	20,10	2	012930008

**Betamax**  
MAXIMUM PERFORMANCE



1293ES/S7 € 92,50 1 012930057

2-2,5-3-4-5-6-8 mm

## 1293BP

chaves hexagonal macho  
com extremidade esférica e punho

**Betamax**  
MAXIMUM PERFORMANCE



mm	L mm	L1 mm	€	U	U
2	100	196	10,50	5	012930501
2,5	100	196	10,50	5	012930502
3	100	196	10,80	5	012930503
4	100	196	12,00	5	012930506
5	100	209	13,40	5	012930509
6	125	245	15,50	5	012930512
8	150	282	21,00	2	012930515

**Betamax**  
MAXIMUM PERFORMANCE



1293BP/S7 € 94,00 1 012930558

2-2,5-3-4-5-6-8 mm

## 1294

chaves para parafusos  
de perfil de fenda sem cabeça

**Betamax**  
MAXIMUM PERFORMANCE

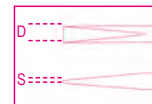

SxDxL mm	L1 mm	€	U	U
0,5x2,5x60	156	7,20	5	012940003
0,6x3x75	171	7,60	5	012940006
0,6x3x100	196	7,80	5	012940009
0,8x4x100	196	9,50	5	012940012
0,8x4x150	246	12,40	5	012940015
1x5x125	234	11,80	5	012940018
1,2x6,5x150	282	14,00	5	012940027

**Betamax**  
MAXIMUM PERFORMANCE



1294/S5 € 50,50 1 012940305

0,5x2,5x60-0,6x3x100  
0,8x4x100-1x5x125  
1,2x6,5x150 mm

## 1294L

chaves série longa para parafusos  
de perfil de fenda sem cabeça

**Betamax**  
MAXIMUM PERFORMANCE

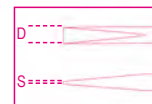
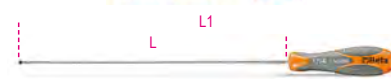

SxDxL mm	L1 mm	€	U	U
0,6x3x300	396	15,70	3	012940206
0,8x4x400	496	18,50	3	012940209
1x5x400	509	22,60	3	012940215
1,2x6,5x400	532	25,50	3	012940218

## 1295

desandador de percussão

12"



L  
mm 130 € 67,00 1 012950001



## 1295/C14

desandador de percussão com 14 pontas e 1 porta pontas



1295/C14 € 176,00 1 012950108

	866LP	1,2x6,5 - 1,6x10 mm
	866PH	PH2 - PH3
	866PZ	PZ2 - PZ3
	866PE	5 - 6 mm
	866TX	T27 - T30 - T40 - T45 - T50 - T55
	895/6	□ 1/2 - ○ 5/16
	1295	■ 1/2

170x100x35 mm - 1,3 kg

## 1297TX

chaves com punho para parafusos de perfil Torx®



Ø	L mm	L1 mm	Ø mm	€	U	U
T6	50	146	3,0	13,60	5	012970006
T7	50	146	3,0	13,80	5	012970007
T8	60	156	3,0	13,90	5	012970008
T9	60	169	4,0	14,40	5	012970009
T10	80	189	4,0	15,40	5	012970010
T15	80	189	4,0	15,50	5	012970015
T20	100	209	4,5	15,90	5	012970020
T25	100	209	5,0	16,40	5	012970025
T27	115	235	6,0	16,90	5	012970027
T30	115	235	6,0	17,80	5	012970030
T40	130	262	7,0	19,80	2	012970040
T45	130	262	8,0	22,50	2	012970045



1297TX/S12 € 196,00 1 012970312  
T6-T7-T8-T9-T10  
T15-T20-T25-T27  
T30-T40-T45



## Betamax



1297TX/D6 € 98,00 1 012970409  
T10-T15-T20  
T25-T27-T30

## 1297TX/L

chaves com punho para parafusos de perfil Torx®, série longa



Ø	L mm	L1 mm	Ø mm	€	U	U
T15	210	319	4,0	17,20	2	012970115
T20	210	319	4,5	17,70	2	012970120
T25	210	319	5,0	18,30	2	012970125
T30	210	330	6,0	19,60	2	012970130
T45	210	342	8,0	21,30	2	012970145



## Betamax



1297TX/L-S5 € 94,00 1 012970325  
TX/L15-TX/L20-TX/L25-  
TX/L30-TX/L45

## 1298RTX

chaves com punho para parafusos de perfil Tamper Resistant Torx®



Ø	L mm	L1 mm	Ø mm	€	U	U
T9	60	169	4,0	15,90	5	012980009
T10	80	189	4,0	16,20	5	012980010
T15	80	189	4,0	17,20	5	012980015
T20	100	209	4,0	17,30	5	012980020
T25	100	209	4,5	17,70	5	012980025
T27	115	235	5,5	19,10	5	012980027
T30	115	235	6,0	19,80	5	012980030
T40	130	262	7,0	21,30	2	012980040



## Betamax



1298RTX/S8 € 145,00 1 012980308  
T9-T10-T15-T20  
T25-T27-T30-T40

## 1299PZ

chaves para parafusos de perfil Pozidriv® - Supadriv®



UNI/ISO 8764

PZ	L mm	L1 mm	€	U	U
0	60	156	10,60	5	012990000
1	80	189	12,50	5	012990003
2	100	220	16,90	5	012990006
3	150	282	24,50	2	012990009
4	200	332	34,50	2	012990012



## Betamax



1299PZ/S6 € 89,50 1 012990306  
1299PZ PZ0-PZ1-PZ2-PZ3  
1299N/PZ PZ1-PZ2

## 1299N/PZ

chaves série curta para parafusos de perfil Pozidriv® - Supadriv®



UNI/ISO 8764

PZ	L mm	L1 mm	€	U	U
1	30	86	12,00	5	012990021
2	30	86	13,40	5	012990024





2024 MotoGP  
World Championship

  
**OFFICIAL SPONSOR**  
MotoGP Team 2024

Fabio  
Quartararo

 **Beta**

50 Years in Motorsports

PARTNERSHIP

20  
24

ALONSO LÓPEZ

FERMÍN ALDEGUER



2024 MOTO2  
WORLD CHAMPIONSHIP



Technical Partner



Official partner of  
aprilia RACING



LEOPARD RACING



Ecosantagata Althea  
Racing Team

